

CONTENT

Water cycle

Water demand.....	p.3
Water intended for human consumption.....	p.6
Aggressive or corrosive water.....	p.7
Diameter selection.....	p.9
Pipeline profile	p.14
Head losses.....	p.16

Pressure and angular deviation at the joint

Pressures (terminology).....	p.30
Allowable operating pressure (PFA) for pipes and fittings (bar).....	p.33
Fitting pressure classes	p.34
PMA and PEA according to the PFA (bar)	p.38
Anchoring	p.39
Calculation of anchoring lengths	p.43
Anchor blocks	p.45
Safety factors	p.48
Water hammers	p.49
Joint deflection.....	p.52

Surrounding conditions of the pipeline

Soils (mechanical properties)	p.54
Unstable ground.....	p.55
Earthworks.....	p.57
Soil aggressivity	p.61
Heights of cover.....	p.63
Soil loads (pipe performance).....	p.67

Standards and quality

Product standards and related standards	p.69
Materials in contact with water intended for human consumption.....	p.70

Sustainable development

Transport and laying	p.71
Life cycle assessment	p.72
Total cost of ownership.....	p.73

WATER CYCLE

Water demand

The design of a system must take into account:

- Water demand, estimated by statistical or analytical methods
- Water resources, determined from the appropriate hydrogeological and hydrological data for each region

Assessment of water demand

Volume

The volume of water needed to supply a community depends on:

- The size and types of the towns being served
- Municipal, agricultural and industrial requirements
- The practices of the population

In general, the following mean daily consumptions are assumed per capita:

- 144.6 liters/inhabitant/day, i.e. 52.79 m³/inhabitant/year (domestic water consumption)
- 157.7 m³/subscriber/year (total water consumption: domestic and non-domestic)

Source: *ONEMA intelligence report on public water and sewerage services: overview of services and performance (2014 data)*.

It is advisable in all cases to design the water supply and distribution systems taking into account the prospects for long-term urban development in the area.

Consideration must be given for any residential buildings or industrial facilities. The average requirements for some common examples are as follows:

- Schools: 100 liters per pupil per day
- Slaughterhouses: 500 liters per head of livestock
- Dairies, butter and cheese-making: 5 liters per liter of processed milk
- Hospitals: 400 liters per bed per day
- Wine-making: 2 liters per liter of product
- Firefighting: a minimum reserve of 120 m³, capable of supplying a DN 100 hydrant for two hours (French standard NF S62-200 – August 2009 – Pillar hydrants and flush hydrants – Rules for installation, delivery acceptance and maintenance); some fire departments may have additional requirements
- Industry: each case has to be studied separately

It is essential to provide a safety margin, to take into account (a) the oversights and the inaccuracies which may affect the estimates and (b) the effective yield of the system,

which is defined as:

$$r = \frac{\text{Volume metered}}{\text{Volume supplied}}$$

$$\text{Gross water requirement} = \frac{\text{Net requirement}}{\text{Volume supplied}} \times K_{sec} \times K_{col}$$

WATER CYCLE

Water demand

□ Flow rates

Communities (large number of subscribers)

Flow requirements are assessed as daily and hourly peaks. A distribution system is usually designed to carry the hourly peak demand.

$$Q_p = K_d \times K_h \times \frac{Vd_{Av.}}{24} \quad (\text{m}^3/\text{h})$$

where:

$$Vd_{Av.} = \frac{V_{annual} (\text{m}^3)}{365} \quad : \text{ average daily consumption throughout the year}$$

$$K_h = \frac{Vh_{max}}{Vd_{max}} \times 24 \quad : \text{ hourly peak coefficient}$$

$$K_d = \frac{Vd_{max}}{Vd_{Av.}} \quad : \text{ daily peak coefficient}$$

Vh_{max} : volume used during the hour of greatest consumption on the day featuring the highest consumption (m^3/hour).

Vd_{max} : volume used on the day featuring the highest consumption during the year (m^3/day).

Residential buildings (low number of subscribers)

Flow requirements are not calculated according to the number of consumers, but the number of appliances (washbasins, sinks, WCs, etc.), weighted by a coefficient of simultaneous usage:

$$Q = k.n.q$$

where:

q : unit flow of an appliance

n : number of appliances ($n > 1$)

k : probability coefficient of simultaneous usage (negligible for large values of n)

$$\text{where: } k = \frac{1}{\sqrt{n-1}}$$

□ Simple example 1

Assumptions

- Semi-rural community:
Current village: 1,500 inhabitants
Future housing developments: 1,000 inhabitants (over 25 years)

- Annual volume metered: $75,000 \text{ m}^3$
- Estimated system performance: $r = 75\%$
- Estimated peak coefficients: $K_d = 2.5$; $K_h = 1.8$

Calculations and results

- Future annual volume:

$$Va_{future} = 75,000 + (0.2 \times 1,000 \times 365) = 148,000 \text{ m}^3$$

(estimated daily consumption per capita: 200 l)

WATER CYCLE

$$K_{col} = \frac{Va_{future}}{Va_{current}} = \frac{148,000}{75,000} = 1.97$$

- Allowance for data uncertainty: 20% ($K_{sec} = 1.2$)

- Gross annual requirement: $G = \frac{Va_{current}}{r} \times K_{col} \times K_{sec} = 236,000 \text{ m}^3$

- Future average daily flow: $Q_{dAv.f} = \frac{236,000}{365} = 647 \text{ m}^3$

- Future peak hourly flow: $Qp = Kd \times Kh \times \frac{Q_{dAv.f}}{24} = 121 \text{ m}^3/\text{h}$

In this example, a supply main for the village should be designed to deliver 121 m³/h within the next 25 years.

Simple example 2

Assumptions

- Residential building:
Ten apartments
Seven appliances per apartment
Average unit flow per appliance: 0.1 l/s

Calculations and results

For example, the booster pump supplying the building must provide a flow of $Q = k.n.q$ where:

$$k = \frac{1}{\sqrt{(7 \times 10) - 1}} = 0.12$$

$$Q = 0.1 \times 70 \times 0.12 = 0.84 \text{ l/s}$$

Water resource evaluation

Water can be collected from both subsurface sources (aquifers and springs) and surface sources (rivers, lakes, dams, etc.).

In all cases, an in-depth study needs to be made of the hydrology, hydrography and hydrogeology of the catchment areas, the yield from which may vary considerably throughout the year.

A series of long-term gauge measurements of springs and rivers or pumping tests on subsurface waters enables a statistical assessment of changes in flow to be made. Those data can then be used to assess the quantity of available water, particularly during dry seasons.

Where the flow of a river is inadequate (low levels), a reservoir has to be created by building a valley or hillside dam.

If no measurements are available, the flow of a river can be estimated at its outlet by various methods related to the morphology and hydrology of its catchment basin.

WATER CYCLE

Water intended for human consumption

European regulations

Council Directive 98/83/EC of 3 November 1998 on the quality of water intended for human consumption, as amended.

The objective of this Directive shall be to protect human health from the adverse effects of any contamination of water intended for human consumption by ensuring that it is wholesome and clean.

Water shall be wholesome and clean if it:

- Is free from any micro-organisms and parasites and from any substances which, in numbers or concentrations, constitute a potential danger to human health, and
- Meets the minimum requirements concerning the parameters set out in the Directive.

The Directive specifies two groups of minimum requirements:

- **Microbiological** parameters (Escherichia coli, Enterococci, etc.)
- **Chemical** parameters (copper, nickel, and so on)

The Directive also specifies parameters that serve as indicators, including:

- Conductivity: 2,500 $\mu\text{S}/\text{cm}$ at 20°C
- Hydrogen ion concentration: ≥ 6.5 and ≤ 9.5 pH units
- Ammonium: 0.50 mg/L
- Chloride: 250 mg/L
- Sulfate: 250 mg/L

The Directive stipulates the minimum requirements that the Member States must incorporate into their national laws. Member States are required to take the necessary measures to ensure that water intended for human consumption is wholesome and clean.

Transposition into French law

In France, the Directive has been transposed into national law by means of Decree 2001-1220 of 20 December 2001, as amended, and the Regulation of 11 January 2007.

The Regulation incorporates and updates the minimum requirements stipulated in the Directive, while including **organoleptic** parameters (color, odor, taste, turbidity, etc.) and **radioactivity** parameters (tritium, TID, etc.).

It specifies the following baseline values for the quality of water intended for human consumption:

- Conductivity:
 - ≥ 180 and $\leq 1,000$ $\mu\text{S}/\text{cm}$ at 20°C
 - ≥ 200 and $\leq 1,100$ $\mu\text{S}/\text{cm}$ at 25°C
- Hydrogen ion concentration: $6.5 \leq \text{pH units} \leq 9$
- Calco-carbonic equilibrium: water must be at calco-carbonic equilibrium or slightly scaling
- Ammonium: 0.10 mg/L
- Chloride: 250 mg/L
- Sulfate: 250 mg/L

The quality of the water distributed to consumers, and therefore its compliance with regulations, is the result of the entire supply chain (source environment, raw water quality, water treatment, pipeline transport, hydraulic equipment, external installations, etc.).

For specific requirements regarding pipes, refer to MATERIALS IN CONTACT WITH WATER INTENDED FOR HUMAN CONSUMPTION on page 70.

WATER CYCLE

Aggressive or corrosive water

Water transported through pipelines may have very different physical and chemical properties. Water can be characterized by its corrosivity (propensity to attack exposed metals) and its aggressivity (towards cement-based materials). **PAM** pipes are internally protected with linings that enable them to carry the various types of water encountered.

The behavior of water towards ferrous metals and cement-based products depends on many factors, including mineralization, oxygen content, electrical conductivity, pH, calco-carbonic equilibrium and temperature.

Two main types of water are taken into account:

- Corrosive water, which can attack uncoated metal
- Aggressive water, which can attack cement-based materials

Corrosive water

Definition

Some types of water can attack metal pipes without an internal coating. The chemical reactions produce ferrous and then ferric hydroxides, forming nodules and tuberculation, which can eventually reduce the pipe's cross-sectional area and significantly increase head loss.



Reality of the phenomenon

This phenomenon is encountered in old mains without an internal cement mortar lining. **PAM** ductile iron pipes are lined internally with cement mortar, polyurethane or Ductan*, which eliminates this risk.

* find out more:

<http://www.pamline.fr/produits/recherche-multi-criteres/catalogue-annexes/reponses-techniques/solutions-techniques-pam/revetements/revetements-interieurs/revetement-ductan>

Note that corrosion by water intended for human consumption is generally a slow process. Drinking water standards recommend the distribution of non-corrosive and non-aggressive water, thereby guaranteeing consistent water quality and protecting pipelines as well as public and private installations.

Refer to WATER INTENDED FOR HUMAN CONSUMPTION on page 6.

WATER CYCLE

Aggressive or corrosive water

Aggressive water

Definition

The aggressivity of water is defined as its propensity to react with materials containing calcium (e.g. hydraulic binders). Depending on the chemical analysis, mineral content, pH and temperature of the water, three cases can occur:

- Water in calco-carbonic equilibrium does not attack or deposit calcium carbonate at a given temperature.
- Scaling water has a tendency to deposit calcium salts (carbonates, etc.) on the pipe's inner surface.
- Aggressive water may attack certain components of cement mortar containing calcium (lime, calcium silicate and calcium silicoaluminate).

Measurement

Aggressivity is determined through water analysis, either using charts indicating the position of the water examined in relation to the equilibrium curve, or simply with software. This method allows rapid characterization of the water, in particular at different temperatures, and allows the free CO₂ content and characteristic indices to be calculated, e.g. the LANGELIER saturation index, which gives the difference between the actual pH value of the water and the saturation pH value.

Reality of the phenomenon

Applicable legislation requires water intended for human consumption to be non-aggressive and non-corrosive. Refer to WATER INTENDED FOR HUMAN CONSUMPTION on page 6.

However, given the many different types of water supplied, water with a low mineral content (soft water) may be encountered that can attack materials, just like corrosive and/or aggressive water.

PAM SAINT-GOBAIN has software for assessing water aggressivity and helping select the best type of internal coating (cement mortar lining or PUR lining).

Contact your local PAM representative for further information.

WATER CYCLE

Diameter selection

The diameter of a pressurized pipe is chosen according to:

- Hydraulic parameters (flow, head losses, velocity, etc.) for gravity supply systems.
- Optimized hydraulic and economic parameters (pumping costs and asset depreciation) for pumped supply systems.

Depending on the operating conditions, there may be a need to quantify the potential risks of a water hammer, cavitation and abrasion, as well as install suitable protective measures.

Gravity-fed supply system

Definition

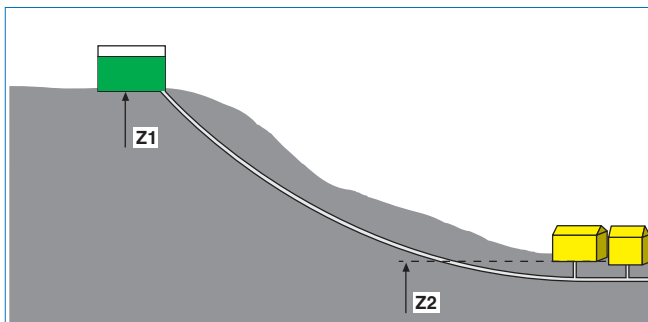

A gravity supply system is the mode of supply which allows water to be driven through a pressure main from a natural or artificial storage area at elevation Z_1 , to all points of supply located at elevations $Z_2 < Z_1$, without any energy input.

Sizing principle

□ System characteristics

- Q : required flow (m^3/s)
- Peak distribution or fire hydrant flow
 - Mean supply flow
- j : unit head loss (m/m)
- V : water velocity through the pipeline (m/s)
- ID : inner diameter of the pipeline (m)
- L : length of the pipeline (m)

WATER CYCLE

Diameter selection

Topographical features

The most unfavorable case is taken for calculation purposes.

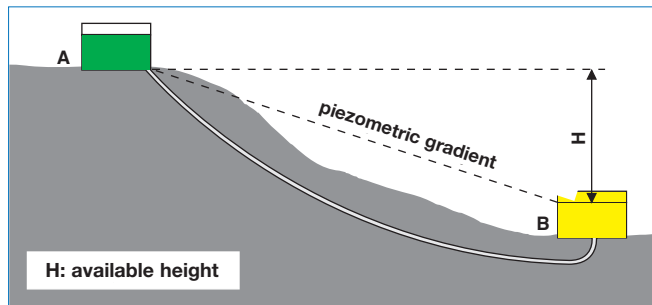

- Supply from reservoir A to reservoir B:

H = minimum height level in A – overflow height of B
As a safety precaution, the foundation slab is sometimes taken as the minimum level of A.

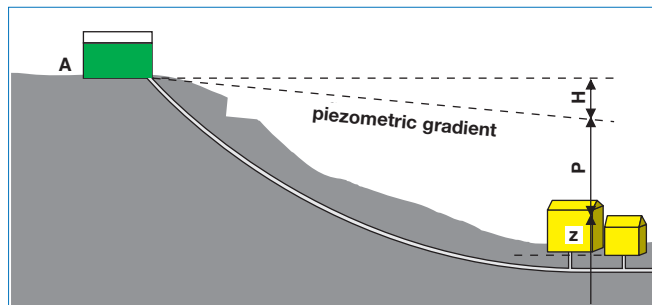

- Distribution

H: minimum level of A, reduced by (z + P)
P: minimum distribution pressure at the highest point
z: vertical datum of the point

Formulae

$$\text{Since: } Q = \frac{\pi ID^2}{4} \times V$$

$$\text{the DARCY equation is written as: } j = \frac{\lambda V^2}{2gID} = \frac{8\lambda Q^2}{\pi^2 g ID^5}$$

λ , a function of (k, ν , ID), is deduced from the COLEBROOK formula, where k = 0.1 mm (roughness).

For more information, refer to HEAD LOSSES on page 16.

Determination of ID

$$\text{The maximum unit head loss is: } j = \frac{H}{L}$$

The DN can be determined:

- By calculating and resolving the system of equations constituted by the DARCY and COLEBROOK formulae (iterative calculations requiring the use of a computer).
- By direct reading of head loss tables.
Refer to HEAD LOSSES (TABLES) on page 18.

Example

Flow: $Q = 30 \text{ L/s}$

Length: $L = 4,000 \text{ m}$

Available height: $H = 80 \text{ m}$

$$j = \frac{H}{L} = \frac{80}{4,000} = 0.02 \text{ m/m} = 20 \text{ m/km}$$

The table shows that DN 150 is required, with:

Velocity: $V = 1.7 \text{ m/s}$

Head loss: $j = 19.244 \text{ m/km}$

WATER CYCLE

Diameter selection

L/s	DN 150		V (m/s)
	j (m/km)		
	k = 0.03 m	k = 0.1 mm	
24.00	11.092	12.552	1.36
26.00	12.867	14.627	1.47
28.00	14.766	16.857	1.58
30.00	16.790	19.244	1.70
32.00	18.937	21.787	1.81
34.00	21.208	24.485	1.92
36.00	23.602	27.339	2.04
38.00	26.119	30.348	2.15
40.00	28.785	33.513	2.26
42.00	31.520	36.833	2.38
44.00	34.404	40.309	2.49
46.00	37.409	43.940	2.60

Design calculation example

Pumped supply

Definition

Pumped distribution

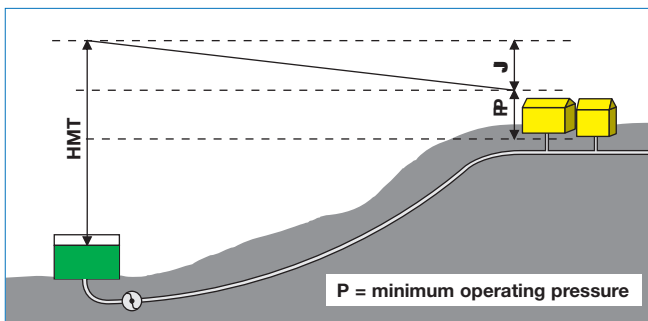

Supply pumped from a reservoir

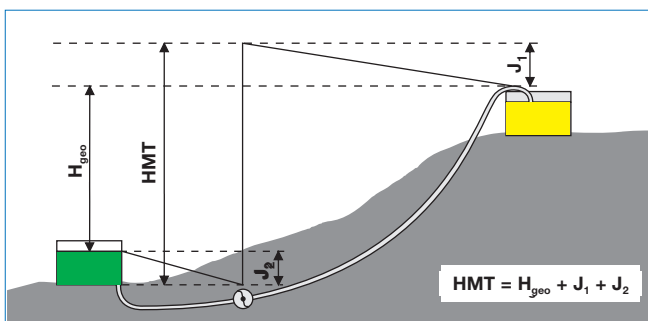

WATER CYCLE

Diameter selection

Borehole pumped supply

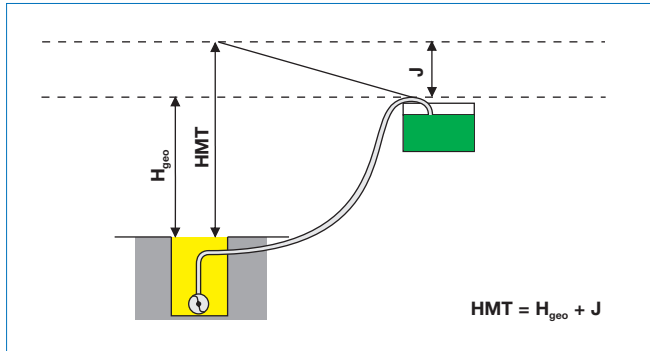

Catchment or storage areas are frequently not high enough to meet the required pressurization conditions. Energy therefore has to be imparted to the liquid to make distribution possible.

The following definitions are used:

- **Geometric height (H_{geo}):** the height difference between the level of the water being pumped and the place supplied.
- **Total manometric height (HMT):** the geometric height, plus the total head losses involved in suction and pumping and, if applicable, the minimum residual distribution pressure (see example figures).

Sizing principle

Graphical resolution

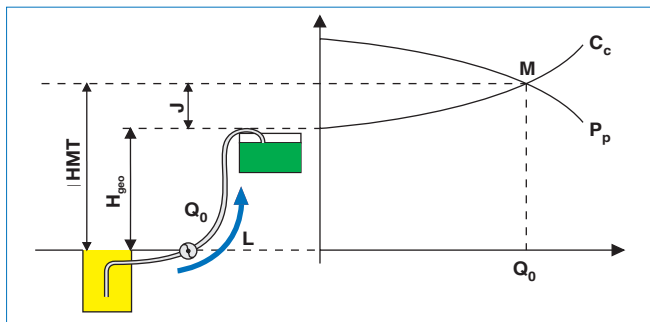

- C_c : pipeline characteristic
- H : $H_{geo} + J$ $J = f(Q^2)$
- P_p : pump characteristic
- M : operating point

Note: Method valid for constant levels of suction and pumping.

Otherwise, the envelope formed by the extreme curves must be taken into account.

Hydraulic sizing

As before:

$$J = j L$$

$$j = \frac{\lambda V^2}{2 g D}$$

λ is a function of ν , k , D .

For pumping, the characteristic curves of the pumps and system have to be taken into account to ensure that operating point M corresponds to the required flow Q_0 according to the chosen DN.

WATER CYCLE

Diameter selection

Economic sizing

The economic diameter is calculated by taking into account:

- The pumping costs, where the power is calculated using the following formula:

$$P = 0.0098 \times \frac{Q \times HMT}{r}$$

where

- P : power to be supplied to the pump shaft (kW)
- Q : flow (L/s)
- HMT : total manometric height (m)
- r : pump motor efficiency
- Asset depreciation (pumping station + main)

Both methods are generally used, depending on the scale of the project.

Application

Small projects

The Vibert formula is used, which applies to small and medium DN's and short lengths:

$$D = 1.456 \left(\frac{ne}{f} \right)^{0.154} \times Q^{0.46}$$

where

- D : economic diameter
- f : installed pipeline cost in €/kg
- Q : flow in m³/s
- $n = \text{pumping time in h} / 24$
- e : price per kWh in €

The 1.456 coefficient covers an 8% depreciation rate over 50 years.

The DN chosen must be identical to diameter D or the next size up.

Precautions

Major projects

A detailed economic study is required in case of long lengths and large diameters. The diameter used must be the one giving the minimum annual cost (depreciation + pumping costs).

The flow rate varies significantly with the diameter.

In addition to head losses, compatibility should be checked with the following phenomena:

- Water hammers
- Cavitation
- Abrasion

WATER CYCLE

Pipeline profile

Air is detrimental to the efficient functioning of a pressure main. Its presence can cause:

- A reduction in flow rate
- Energy wastage
- Increased likelihood of transient phenomena (water hammers)

It can be prevented by taking a number of simple precautions when planning the pipeline profile.

Source of air in pipelines

Air may primarily be introduced into a main:

- During filling following a hydrostatic test (or emptying a main), because of an inadequate number of purging devices.
- Through pump strainers, if the suction pipes or pump seals are not leaktight.
- As dissolved air under pressure and degassing when the pressure falls (the air then accumulates at high spots along the profile).

Effect of air in mains

Air is detrimental to the efficient functioning of a main. Upstream pressure causes air pockets to accumulate at high spots and distort, with their ends forming at different heights.

Case of a gravity main

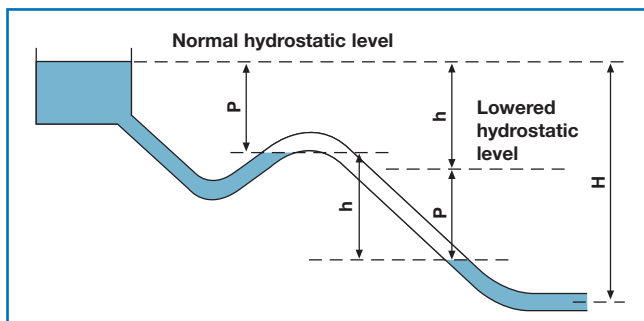

The air pocket transmits static pressure P from its upstream face to the downstream face and the hydrostatic level drops. Operating pressure H is reduced by quantity h , corresponding to the difference in level between the ends of the air pocket and the missing head height.

Dynamically, it can be considered that, neglecting the head loss due to any turbulence at this point, the pressure reduction is also equal to h , and the flow is correspondingly reduced.

WATER CYCLE

Pipeline profile

Case of a pumping main

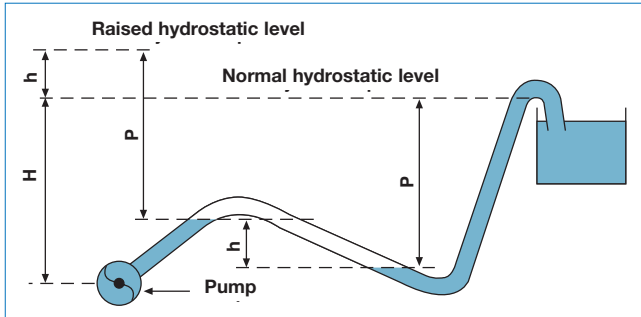

In the same way as in a gravity main, the presence of air pockets is detrimental to the effective performance of a pumping main. In this case, there is a pressure increase h (height h of the additional head to be lifted), which the pump must supply in addition to pressure H in order to compensate for the increased head due to the air pocket, with the hydrostatic level being raised by this value. For the same flow rate, the energy consumption is increased proportionally.

Furthermore, these disadvantages are repeated at every high spot if the main is inadequately purged. The effects are cumulative, and the performance of the main drops. This fall in performance is sometimes incorrectly attributed to other causes, such as a drop in pump efficiency or deposits in the pipes. Purging the main is sufficient to immediately restore normal flow capacity.

Finally, there is a risk of large air pockets being drawn along by the flow and carried to points other than the high spots. Their displacement, compensated for by a sudden rush of water of equal volume, results in violent water hammers.

In summary, if high spots are not consistently purged:

- Water flow is diminished.
- Energy is wasted.
- Water hammers may occur.

Practical recommendations

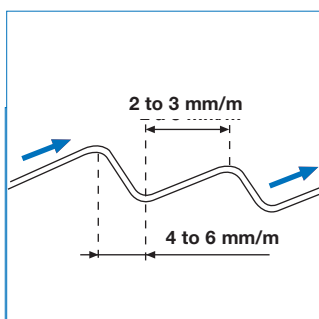
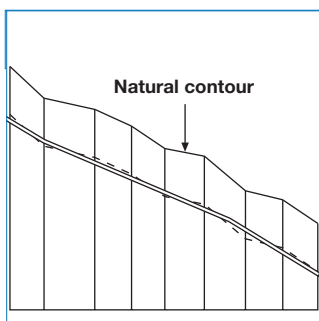

A pipeline layout must be designed to facilitate air accumulation at clearly defined high spots, where purging equipment must be installed.

The following precautions should be taken:

- Provide the main with a gradient to facilitate upward movement of the air (the ideal pipeline has a steady gradient: the desirable minimum gradient is 2 to 3 mm/m).
 - Avoid excessive gradient changes caused by following the contours of the ground, particularly for large diameter pipes.
 - If the profile is horizontal, create as many artificial high and low spots as possible to give gradients of:
 - 2 to 3 mm/m in ascending sections.
 - 4 to 6 mm/m in descending sections.
- Profiles of this type, with gradual ascents and rapid descents, help air pockets to form at high spots, while preventing air from being drawn further into the pipeline. The opposite type of profile is not recommended.
- Install:
 - An air vent valve at every high spot.
 - A blowdown device at every low spot.

WATER CYCLE

Head losses

Head losses are hydraulic energy losses essentially caused by the water viscosity and its friction against the pipe walls.

The effect is:

- An overall pressure drop at the lower end of a gravity system.
- An increase in energy consumption in a pumping main. When choosing a ductile iron main lined with cement mortar, a roughness coefficient of $k = 0.1$ mm is generally applied.

Formulae

DARCY equation

Head losses are calculated using the DARCY equation:

$$j = \frac{\lambda}{D} \frac{V^2}{2g} = \frac{8 \lambda Q^2}{\pi^2 g D^5}$$

J : head losses (m of fluid head per m of pipe)

λ : head loss coefficient

D : inner pipe diameter (m)

V : fluid velocity (m/s)

Q : flow rate (m³/s)

g : acceleration due to gravity (m/s²)

Colebrook-White formula

The COLEBROOK-WHITE formula is now universally used for determining the head loss coefficient:

$$\frac{1}{\sqrt{\lambda}} = -2 \log \left(\frac{2.51}{\text{Re} \sqrt{\lambda}} + \frac{k}{3.71 D} \right)$$

$$\text{Re} = \frac{VD}{\mu} \quad (\text{Reynolds NUMBER})$$

μ : kinematic viscosity of the fluid at the operating temperature (m²/s)

k : the equivalent pipe surface roughness (in m); note that k is not equal to the height of the surface imperfections: it is a theoretical concept relating to the surface roughness, hence the term "equivalent"

The two terms in the logarithmic function correspond to:

- For the first term $\left(\frac{2.51}{\text{Re} \sqrt{\lambda}} \right)$, the portion of head losses due to the liquid's own internal friction acting upon itself

WATER CYCLE

Head losses

– For the second term $\left(\frac{k}{3.71 D}\right)$, the portion of head losses caused by the friction of the liquid against the pipe wall; for a perfectly smooth pipe ($k = 0$), the head losses are only due to the internal friction of the fluid

Hazen-Williams equation

$$V = 0.355 CD^{0.63} J^{0.54}$$

C: coefficient dependent on the roughness and pipe diameter

Surface roughness of cement mortar linings

Spun cement mortar linings have a smooth and even surface. A series of tests has been carried out to determine the roughness value k of the surface of freshly spun pipes. An average value of 0.03 mm was obtained, corresponding to an extra head loss of 5 to 7% (depending on pipe diameter) when compared to a perfectly smooth pipe with a k value of 0 (calculated for a velocity of 1 m/s).

However, the equivalent surface roughness of a pipeline not only depends on the evenness of the pipe surface, but especially on the number of bends, tees and service connections, as well as any irregularities in the pipeline profile. Experience has shown that $k = 0.1$ mm is a reasonable value for pipelines carrying water intended for human consumption. For long mains with only a few connections per kilometer, k may be slightly lower (0.06 to 0.08 mm).

Three comments can be made at this stage about head losses in pressurized water mains:



The head losses correspond to the energy that must be supplied for the water to flow through the pipeline. It is the **sum of three factors**:

- a – Internal water friction (linked to the viscosity)
- b – Water friction along the pipe wall (linked to the roughness)
- c – Local changes to the flow (addition of bends, joints, etc.)



In practice, **most of the head losses** can be attributed to the **internal water friction** (factor a). Water friction on the pipe wall (factor b), **which is the only factor that depends on the type of pipe**, is much less: at most, 7% of the factor for a cement-lined iron pipe ($k = 0.03$ mm).

Local changes to the flow (factor c) also play a minor part in comparison to factor a, which explains why pipe sockets can be fitted in either direction.

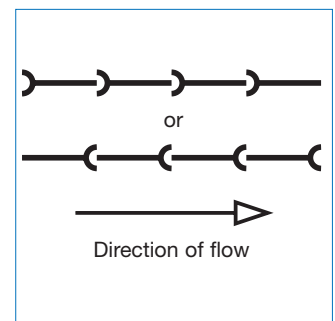

The actual inner diameter of the pipe plays a major role:

- At a given flow rate (general case), each % less in diameter equates to 5% more head loss.
- At a given head loss (gravity pipelines), each % less in diameter equates to 2.5% less in the resultant flow rate.

WATER CYCLE

Head losses

Changes over time

A series of investigations carried out on old and recent cement-lined pipelines in the US has produced C values (according to the Hazen-Williams equation) for a large range of diameters and service lives.

The results are summarized in the table below, which shows C values converted to equivalent k values (in the Colebrook-White formula).

Note

In some cases when transporting raw water with a high solid fraction content at a low flow velocity, experience has shown that an increase in k over time must be factored in, irrespective of the type of pipe used.

The results cover different types of cement mortar linings and water from widely spread geographical locations.



It can be concluded that:

- Cement mortar-lined pipes provide a large flow capacity that remains constant over time.
- An overall value of $k = 0.1 \text{ mm}$ is a reasonable and sound assumption for calculating long-term head losses in cement mortar-lined pipes designed to carry water intended for human consumption.

DN	Year of installation	Age when measurements taken	Value of coefficient C (Hazen-Williams)	Value of k (Colebrook-White)
		years		
150	1941	0	145	0.025
		12	146	0.019
		16	143	0.060
250	1925	16	134	0.148
		32	135	0.135
		39	138	0.098
300	1928	13	134	0.160
		29	137	0.119
		36	146	0.030
300	1928	13	143	0.054
		29	140	0.075
		36	140	0.075
700	1939	19	148	0.027
		25	146	0.046
700	1944	13	148	0.027
		20	146	0.046

(Journal AWWA – June 1974)

WATER CYCLE

Head losses (tables)

Head losses have been calculated for ductile iron pipelines with a cement mortar lining.

Assumptions for the calculation:

- The pipeline is full of water*
- DN 40 to 2000*
- Roughness coefficient: $k = 0.03 \text{ mm}$ and $k = 0.1 \text{ mm}$*
- Kinematic viscosity of water: $\nu = 1.301 \cdot 10^{-6} \text{ m}^2/\text{s}$*
- Water temperature: $T = 10^\circ\text{C}$*

For BLUTOP[®] pipelines internally coated with DUCTAN, the calculation assumptions used are as follows:

- The pipeline is full of water*
- DN/OD (outside diameter) 75, 90, 110, 125, 140 and 160*
- Roughness coefficient:*
 - $k = 0.01 \text{ mm}$*
 - $k = 0.05 \text{ mm}$ (including singular head losses)*
- Kinematic viscosity of water: $\nu = 1.301 \cdot 10^{-6} \text{ m}^2/\text{s}$*
- Water temperature: $T = 10^\circ\text{C}$*

WATER CYCLE

Head losses (tables)

Q (L/s)	DN 60			DN 80			DN 100		
	j (m/km)*		V (m/s)	j (m/km)*		V (m/s)	j (m/km)*		V (m/s)
	k = 0.03 m	k = 0.10 mm		k = 0.03 m	k = 0.10 mm		k = 0.03 m	k = 0.10 mm	
1.50	6.184	6.763	0.53						
1.60	6.943	7.620	0.57						
1.70	7.743	8.524	0.60						
1.80	8.582	9.478	0.64						
2.00	10.379	11.529	0.71						
2.20	12.333	13.775	0.78						
2.40	14.442	16.213	0.85						
2.60	16.705	18.843	0.92	4.128	4.486	0.52			
2.80	19.120	21.665	0.99	4.717	5.145	0.56			
3.00	21.688	24.679	1.06	5.342	5.846	0.60			
3.20	24.407	27.884	1.13	6.002	6.591	0.64			
3.40	27.277	31.280	1.20	6.697	7.378	0.68			
3.60	30.296	34.868	1.27	7.427	8.208	0.72			
3.80	33.465	38.646	1.34	8.193	9.081	0.76			
4.00	36.782	42.615	1.41	8.993	9.996	0.80	3.044	3.294	0.51
4.20	40.248	46.775	1.49	9.827	10.953	0.84	3.324	3.604	0.53
4.40	43.861	51.125	1.56	10.696	11.954	0.88	3.615	3.929	0.56
4.60	47.622	55.666	1.63	11.599	12.996	0.92	3.917	4.266	0.59
4.80	51.531	60.397	1.70	12.536	14.081	0.95	4.230	4.617	0.61
5.00	55.586	65.319	1.77	13.508	15.208	0.99	4.555	4.982	0.64
5.20	59.787	70.431	1.84	14.513	16.377	1.03	4.890	5.359	0.66
5.40	64.136	75.733	1.91	15.551	17.589	1.07	5.236	5.750	0.69
5.60	68.630	81.225	1.98	16.624	18.843	1.11	5.594	6.154	0.71
5.80	73.270	86.908	2.05	17.730	20.139	1.15	5.962	6.571	0.74
6.00	78.055	92.781	2.12	18.869	21.477	1.19	6.341	7.002	0.76
6.20	82.986	98.844	2.19	20.042	22.858	1.23	6.731	7.445	0.79
6.40	88.063	105.096	2.26	21.248	24.280	1.27	7.131	7.902	0.81
6.60	93.284	111.539	2.33	22.488	25.745	1.31	7.543	8.372	0.84
6.80	98.650	118.172	2.41	23.761	27.252	1.35	7.965	8.855	0.87
7.00	104.162	124.995	2.48	25.067	28.801	1.39	8.398	9.352	0.89
7.20	109.817	132.008	2.55	26.406	30.391	1.43	8.842	9.861	0.92
7.40	115.618	139.211	2.62	27.778	32.024	1.47	9.296	10.384	0.94
7.60	121.563	146.604	2.69	29.183	33.699	1.51	9.761	10.920	0.97
7.80	127.652	154.187	2.76	30.620	35.416	1.55	10.236	11.469	0.99
8.00	133.885	161.960	2.83	32.091	37.175	1.59	10.722	12.031	1.02
8.20	140.263	169.922	2.90	33.595	38.976	1.63	11.219	12.606	1.04
8.40	146.784	178.075	2.97	35.131	40.819	1.67	11.726	13.194	1.07
8.60				36.700	42.704	1.71	12.243	13.795	1.09
8.80				38.302	44.631	1.75	12.772	14.410	1.12
9.00				39.937	46.600	1.79	13.310	15.037	1.15
9.50				44.166	51.707	1.89	14.703	16.663	1.21
10.00				48.599	57.075	1.99	16.160	18.371	1.27
10.50				53.234	62.705	2.09	17.683	20.160	1.34
11.00				58.073	68.598	2.19	19.270	22.031	1.40
11.50				63.114	74.752	2.29	20.922	23.983	1.46
12.00				68.356	81.169	2.39	22.639	26.017	1.53
12.50				73.801	87.847	2.49	24.420	28.133	1.59
13.00				79.447	94.788	2.59	26.264	30.330	1.66
13.50				85.294	101.990	2.69	28.173	32.608	1.72
14.00				91.342	109.454	2.79	30.146	34.968	1.78
15.00				104.040	125.167	2.98	34.283	39.931	1.91
16.00							38.674	45.220	2.04
17.00							43.318	50.834	2.16
18.00							48.216	56.773	2.29
19.00							53.366	63.037	2.42
20.00							58.768	69.626	2.55
21.00							64.422	76.539	2.67
22.00							70.327	83.778	2.80
23.00							76.482	91.341	2.93

Figures directly applicable for water at 10°C

* Head (in meters) of the fluid as it flows through a standard kilometer of the pipe.

WATER CYCLE

Head losses (tables)

Q (L/s)	DN 125			DN 150			DN 200		
	j (m/km)*		V (m/s)	j (m/km)*		V (m/s)	j (m/km)*		V (m/s)
	k = 0.03 m	k = 0.10 mm		k = 0.03 m	k = 0.10 mm		k = 0.03 m	k = 0.10 mm	
7.00	2.832	3.070	0.57						
7.50	3.209	3.490	0.61						
8.00	3.607	3.936	0.65						
8.50	4.027	4.408	0.69						
9.00	4.469	4.906	0.73	1.844	1.984	0.51			
9.50	4.931	5.429	0.77	2.034	2.193	0.54			
10.00	5.415	5.977	0.81	2.232	2.412	0.57			
10.50	5.920	6.552	0.86	2.438	2.641	0.59			
11.00	6.445	7.151	0.90	2.653	2.880	0.62			
11.50	6.992	7.777	0.94	2.876	3.129	0.65			
12.00	7.559	8.428	0.98	3.107	3.388	0.68			
12.50	8.147	9.104	1.02	3.347	3.656	0.71			
13.00	8.756	9.806	1.06	3.595	3.935	0.74			
13.50	9.385	10.533	1.10	3.852	4.224	0.76			
14.00	10.035	11.285	1.14	4.116	4.522	0.79			
14.50	10.705	12.063	1.18	4.389	4.830	0.82			
15.00	11.396	12.867	1.22	4.669	5.149	0.85			
15.50	12.107	13.695	1.26	4.958	5.477	0.88			
16.00	12.838	14.549	1.30	5.255	5.814	0.91	1.297	1.389	0.51
16.50	13.590	15.429	1.34	5.560	6.162	0.93	1.371	1.471	0.53
17.00	14.362	16.333	1.39	5.873	6.519	0.96	1.448	1.555	0.54
17.50	15.154	17.263	1.43	6.194	6.887	0.99	1.526	1.641	0.56
18.00	15.966	18.219	1.47	6.523	7.264	1.02	1.606	1.729	0.57
18.50	16.799	19.199	1.51	6.861	7.651	1.05	1.688	1.820	0.59
19.00	17.651	20.205	1.55	7.206	8.047	1.08	1.772	1.913	0.60
19.50	18.524	21.237	1.59	7.559	8.454	1.10	1.858	2.008	0.62
20.00	19.416	22.293	1.63	7.920	8.870	1.13	1.945	2.105	0.64
20.50	20.329	23.375	1.67	8.289	9.296	1.16	2.035	2.204	0.65
21.00	21.262	24.482	1.71	8.665	9.732	1.19	2.126	2.306	0.67
21.50	22.214	25.614	1.75	9.050	10.177	1.22	2.219	2.410	0.68
22.00	23.187	26.772	1.79	9.443	10.633	1.24	2.314	2.516	0.70
22.50	24.180	27.955	1.83	9.843	11.098	1.27	2.411	2.624	0.72
23.00	25.192	29.163	1.87	10.252	11.573	1.30	2.510	2.734	0.73
23.50	26.224	30.397	1.91	10.668	12.057	1.33	2.611	2.847	0.75
24.00	27.277	31.655	1.96	11.092	12.552	1.36	2.713	2.962	0.76
26.00	31.684	36.942	2.12	12.867	14.627	1.47	3.141	3.443	0.83
28.00	36.408	42.633	2.28	14.766	16.857	1.58	3.599	3.959	0.89
30.00	41.448	48.728	2.44	16.790	19.244	1.70	4.085	4.510	0.95
32.00	46.802	55.226	2.61	18.937	21.787	1.81	4.600	5.096	1.02
34.00	52.471	62.128	2.77	21.208	24.485	1.92	5.144	5.717	1.08
36.00	58.454	69.432	2.93	23.602	27.339	2.04	5.717	6.372	1.15
38.00				26.119	30.348	2.15	6.317	7.063	1.21
40.00				28.758	33.513	2.26	6.946	7.788	1.27
42.00				31.520	36.833	2.38	7.604	8.548	1.34
44.00				34.404	40.309	2.49	8.289	9.342	1.40
46.00				37.409	43.940	2.60	9.003	10.172	1.46
48.00				40.537	47.726	2.72	9.744	11.035	1.53
50.00				43.786	51.668	2.83	10.514	11.934	1.59
55.00							12.559	14.332	1.75
60.00							14.777	16.946	1.91
65.00							17.168	19.777	2.07
70.00							19.731	22.823	2.23
75.00							22.465	26.085	2.39
80.00							25.370	29.564	2.55
85.00							28.446	33.258	2.71
90.00							31.692	37.167	2.86

Figures directly applicable for water at 10°C

* Head (in meters) of the fluid as it flows through a standard kilometer of the pipe.

WATER CYCLE

Head losses (tables)

Q (L/s)	DN 250			DN 300			DN 350		
	j (m/km)*		V (m/s)	j (m/km)*		V (m/s)	j (m/km)*		V (m/s)
	k = 0.03 m	k = 0.10 mm		k = 0.03 m	k = 0.10 mm		k = 0.03 m	k = 0.10 mm	
30.00	1.377	1.483	0.61						
32.00	1.549	1.673	0.65						
34.00	1.730	1.874	0.69						
36.00	1.921	2.086	0.73	0.792	0.844	0.51			
38.00	2.121	2.309	0.77	0.874	0.934	0.54			
40.00	2.330	2.543	0.81	0.960	1.027	0.57			
42.00	2.549	2.788	0.86	1.049	1.125	0.59			
44.00	2.776	3.044	0.90	1.142	1.227	0.62			
46.00	3.013	3.310	0.94	1.238	1.334	0.65			
48.00	3.258	3.588	0.98	1.339	1.445	0.68			
50.00	3.513	3.876	1.02	1.442	1.559	0.71	0.682	0.726	0.52
52.00	3.776	4.176	1.06	1.550	1.679	0.74	0.732	0.781	0.54
54.00	4.049	4.486	1.10	1.661	1.802	0.76	0.785	0.838	0.56
56.00	4.331	4.807	1.14	1.776	1.930	0.79	0.838	0.897	0.58
58.00	4.621	5.139	1.18	1.894	2.062	0.82	0.894	0.958	0.60
60.00	4.920	5.482	1.22	2.016	2.198	0.85	0.951	1.021	0.62
62.00	5.229	5.836	1.26	2.141	2.338	0.88	1.010	1.085	0.64
64.00	5.546	6.200	1.30	2.270	2.483	0.91	1.070	1.152	0.67
66.00	5.872	6.575	1.34	2.402	2.631	0.93	1.132	1.220	0.69
68.00	6.207	6.961	1.39	2.538	2.784	0.96	1.196	1.290	0.71
70.00	6.550	7.358	1.43	2.677	2.942	0.99	1.261	1.363	0.73
72.00	6.902	7.766	1.47	2.820	3.103	1.02	1.328	1.437	0.75
74.00	7.264	8.185	1.51	2.967	3.269	1.05	1.397	1.513	0.77
76.00	7.634	8.614	1.55	3.116	3.438	1.08	1.467	1.591	0.79
78.00	8.012	9.054	1.59	3.270	3.612	1.10	1.539	1.670	0.81
80.00	8.400	9.505	1.63	3.427	3.790	1.13	1.612	1.752	0.83
85.00	9.406	10.680	1.73	3.834	4.254	1.20	1.802	1.965	0.88
90.00	10.467	11.922	1.83	4.262	4.744	1.27	2.002	2.189	0.94
95.00	11.583	13.232	1.94	4.713	5.260	1.34	2.213	2.425	0.99
100.00	12.752	14.609	2.04	5.184	5.802	1.41	2.433	2.673	1.04
105.00	13.976	16.053	2.14	5.677	6.371	1.49	2.662	2.932	1.09
110.00	15.253	17.565	2.24	6.192	6.965	1.56	2.902	3.204	1.14
115.00	16.584	19.144	2.34	6.727	7.586	1.63	3.151	3.487	1.20
120.00	17.969	20.790	2.44	7.284	8.232	1.70	3.410	3.782	1.25
125.00	19.407	22.504	2.55	7.862	8.905	1.77	3.679	4.088	1.30
130.00	20.899	24.285	2.65	8.460	9.604	1.84	3.957	4.406	1.35
135.00	22.444	26.134	2.75	9.080	10.329	1.91	4.245	4.736	1.40
140.00	24.043	28.049	2.85	9.721	11.080	1.98	4.542	5.078	1.46
145.00	25.695	30.032	2.95	10.383	11.856	2.05	4.849	5.431	1.51
150.00				11.066	12.659	2.12	5.166	5.796	1.56
155.00				11.770	13.488	2.19	5.492	6.173	1.61
160.00				12.495	14.343	2.26	5.828	6.561	1.66
165.00				13.240	15.224	2.33	6.173	6.961	1.71
170.00				14.007	16.131	2.41	6.528	7.373	1.77
175.00				14.794	17.064	2.48	6.892	7.796	1.82
180.00				15.602	18.023	2.55	7.266	8.231	1.87
185.00				16.431	19.008	2.62	7.649	8.678	1.92
190.00				17.281	20.019	2.69	8.041	9.136	1.97
195.00				18.151	21.056	2.76	8.443	9.606	2.03
200.00				19.042	22.119	2.83	8.855	10.088	2.08
210.00				20.886	24.323	2.97	9.706	11.086	2.18
220.00							10.594	12.131	2.29
230.00							11.520	13.223	2.39
240.00							12.484	14.361	2.49
250.00							13.485	15.546	2.60
260.00							14.523	16.777	2.70
270.00							15.599	18.055	2.81
280.00							16.712	19.379	2.91

Figures directly applicable for water at 10°C

* Head (in meters) of the fluid as it flows through a standard kilometer of the pipe.

WATER CYCLE

Head losses (tables)

Q (L/s)	DN 400			DN 450			DN 500		
	j (m/km)*		V (m/s)	j (m/km)*		V (m/s)	j (m/km)*		V (m/s)
	k = 0.03 m	k = 0.10 mm		k = 0.03 m	k = 0.10 mm		k = 0.03 m	k = 0.10 mm	
65.00	0.575	0.612	0.52						
70.00	0.659	0.702	0.56						
75.00	0.747	0.799	0.60						
80.00	0.841	0.902	0.64	0.474	0.503	0.50			
85.00	0.940	1.010	0.68	0.530	0.564	0.53			
90.00	1.044	1.125	0.72	0.588	0.627	0.57			
95.00	1.153	1.245	0.76	0.650	0.694	0.60			
100.00	1.267	1.371	0.80	0.713	0.764	0.63	0.428	0.453	0.51
105.00	1.385	1.504	0.84	0.780	0.837	0.66	0.467	0.496	0.53
110.00	1.509	1.642	0.88	0.850	0.913	0.69	0.509	0.542	0.56
115.00	1.638	1.786	0.92	0.922	0.993	0.72	0.552	0.588	0.59
120.00	1.772	1.935	0.95	0.997	1.075	0.75	0.597	0.637	0.61
125.00	1.911	2.091	0.99	1.075	1.161	0.79	0.643	0.688	0.64
130.00	2.055	2.253	1.03	1.155	1.251	0.82	0.691	0.740	0.66
135.00	2.204	2.420	1.07	1.239	1.343	0.85	0.741	0.795	0.69
140.00	2.357	2.594	1.11	1.324	1.438	0.88	0.792	0.851	0.71
145.00	2.516	2.773	1.15	1.413	1.537	0.91	0.845	0.909	0.74
150.00	2.679	2.958	1.19	1.504	1.639	0.94	0.899	0.969	0.76
155.00	2.847	3.149	1.23	1.598	1.744	0.97	0.955	1.031	0.79
160.00	3.020	3.345	1.27	1.695	1.852	1.01	1.013	1.094	0.81
165.00	3.198	3.548	1.31	1.794	1.964	1.04	1.072	1.160	0.84
170.00	3.380	3.756	1.35	1.896	2.079	1.07	1.132	1.227	0.87
175.00	3.568	3.971	1.39	2.001	2.196	1.10	1.195	1.296	0.89
180.00	3.760	4.191	1.43	2.108	2.317	1.13	1.259	1.368	0.92
185.00	3.957	4.417	1.47	2.218	2.442	1.16	1.324	1.440	0.94
190.00	4.159	4.648	1.51	2.331	2.569	1.19	1.391	1.515	0.97
195.00	4.366	4.886	1.55	2.446	2.699	1.23	1.459	1.592	0.99
200.00	4.577	5.129	1.59	2.564	2.833	1.26	1.529	1.670	1.02
210.00	5.014	5.634	1.67	2.807	3.110	1.32	1.674	1.832	1.07
220.00	5.471	6.161	1.75	3.061	3.399	1.38	1.825	2.002	1.12
230.00	5.946	6.712	1.83	3.326	3.701	1.45	1.982	2.179	1.17
240.00	6.440	7.286	1.91	3.601	4.016	1.51	2.145	2.363	1.22
250.00	6.953	7.883	1.99	3.886	4.344	1.57	2.314	2.555	1.27
260.00	7.485	8.504	2.07	4.182	4.684	1.63	2.489	2.753	1.32
270.00	8.035	9.148	2.15	4.488	5.036	1.70	2.671	2.960	1.38
280.00	8.605	9.815	2.23	4.804	5.401	1.76	2.858	3.173	1.43
290.00	9.193	10.506	2.31	5.131	5.779	1.82	3.051	3.394	1.48
300.00	9.800	11.219	2.39	5.468	6.170	1.89	3.251	3.622	1.53
310.00	10.426	11.956	2.47	5.815	6.573	1.95	3.456	3.857	1.58
320.00	11.071	12.716	2.55	6.173	6.988	2.01	3.668	4.100	1.63
330.00	11.734	13.499	2.63	6.541	7.417	2.07	3.885	4.350	1.68
340.00	12.416	14.306	2.71	6.919	7.857	2.14	4.109	4.607	1.73
350.00	13.117	15.136	2.79	7.307	8.311	2.20	4.338	4.872	1.78
360.00	13.836	15.989	2.86	7.705	8.777	2.26	4.574	5.144	1.83
370.00	14.574	16.865	2.94	8.114	9.255	2.33	4.815	5.423	1.88
380.00				8.533	9.747	2.39	5.062	5.709	1.94
390.00				8.962	10.250	2.45	5.316	6.003	1.99
400.00				9.401	10.767	2.52	5.575	6.304	2.04
420.00				10.310	11.837	2.64	6.111	6.928	2.14
440.00				11.259	12.958	2.77	6.671	7.581	2.24
460.00				12.249	14.129	2.89	7.255	8.263	2.34
480.00							7.862	8.974	2.44
500.00							8.493	9.714	2.55
520.00							9.147	10.483	2.65
540.00							9.825	11.282	2.75
560.00							10.526	12.109	2.85
580.00							11.251	12.965	2.95

Figures directly applicable for water at 10°C

* Head (in meters) of the fluid as it flows through a standard kilometer of the pipe.

WATER CYCLE

Head losses (tables)

Q (L/s)	DN 600			DN 700			DN 800		
	j (m/km)*		V (m/s)	j (m/km)*		V (m/s)	j (m/km)*		V (m/s)
	k = 0.03 m	k = 0.10 mm		k = 0.03 m	k = 0.10 mm		k = 0.03 m	k = 0.10 mm	
160.00	0.417	0.443	0.57						
170.00	0.466	0.496	0.60						
180.00	0.517	0.552	0.64						
190.00	0.571	0.611	0.67						
200.00	0.628	0.673	0.71	0.296	0.313	0.52			
210.00	0.687	0.737	0.74	0.324	0.343	0.55			
220.00	0.748	0.805	0.78	0.353	0.375	0.57			
230.00	0.812	0.875	0.81	0.383	0.407	0.60			
240.00	0.878	0.949	0.85	0.414	0.441	0.62			
250.00	0.947	1.025	0.88	0.446	0.476	0.65			
260.00	1.018	1.104	0.92	0.480	0.512	0.68	0.251	0.265	0.52
270.00	1.092	1.186	0.95	0.514	0.550	0.70	0.269	0.284	0.54
280.00	1.168	1.271	0.99	0.550	0.589	0.73	0.287	0.304	0.56
290.00	1.247	1.358	1.03	0.587	0.629	0.75	0.306	0.325	0.58
300.00	1.327	1.449	1.06	0.625	0.671	0.78	0.326	0.346	0.60
310.00	1.411	1.542	1.10	0.664	0.714	0.81	0.346	0.368	0.62
320.00	1.496	1.638	1.13	0.704	0.758	0.83	0.367	0.390	0.64
330.00	1.584	1.737	1.17	0.745	0.804	0.86	0.388	0.414	0.66
340.00	1.675	1.839	1.20	0.787	0.850	0.88	0.410	0.438	0.68
350.00	1.768	1.943	1.24	0.830	0.898	0.91	0.433	0.462	0.70
360.00	1.863	2.051	1.27	0.875	0.947	0.94	0.456	0.487	0.72
370.00	1.960	2.161	1.31	0.921	0.998	0.96	0.479	0.513	0.74
380.00	2.060	2.274	1.34	0.967	1.050	0.99	0.504	0.540	0.76
390.00	2.163	2.390	1.38	1.015	1.103	1.01	0.528	0.567	0.78
400.00	2.267	2.509	1.41	1.064	1.157	1.04	0.554	0.594	0.80
420.00	2.483	2.755	1.49	1.165	1.270	1.09	0.606	0.652	0.84
440.00	2.709	3.013	1.56	1.270	1.388	1.14	0.660	0.712	0.88
460.00	2.944	3.281	1.63	1.379	1.510	1.20	0.717	0.774	0.92
480.00	3.189	3.561	1.70	1.493	1.638	1.25	0.776	0.839	0.95
500.00	3.442	3.853	1.77	1.611	1.771	1.30	0.837	0.907	0.99
520.00	3.705	4.155	1.84	1.733	1.909	1.35	0.900	0.977	1.03
540.00	3.977	4.469	1.91	1.860	2.053	1.40	0.965	1.050	1.07
560.00	4.259	4.794	1.98	1.990	2.201	1.46	1.033	1.125	1.11
580.00	4.550	5.131	2.05	2.125	2.354	1.51	1.102	1.203	1.15
600.00	4.850	5.478	2.12	2.265	2.513	1.56	1.174	1.284	1.19
620.00	5.159	5.837	2.19	2.408	2.676	1.61	1.248	1.367	1.23
640.00	5.477	6.208	2.26	2.556	2.845	1.66	1.324	1.452	1.27
660.00	5.805	6.589	2.33	2.707	3.018	1.71	1.403	1.540	1.31
680.00	6.142	6.982	2.41	2.863	3.197	1.77	1.483	1.631	1.35
700.00	6.488	7.386	2.48	3.024	3.381	1.82	1.566	1.724	1.39
720.00	6.843	7.801	2.55	3.188	3.569	1.87	1.650	1.820	1.43
740.00	7.207	8.228	2.62	3.357	3.763	1.92	1.737	1.918	1.47
760.00	7.581	8.666	2.69	3.529	3.962	1.97	1.826	2.019	1.51
780.00	7.963	9.115	2.76	3.706	4.166	2.03	1.917	2.122	1.55
800.00	8.355	9.575	2.83	3.887	4.375	2.08	2.010	2.228	1.59
850.00				4.358	4.920	2.21	2.252	2.503	1.69
900.00				4.855	5.497	2.34	2.507	2.795	1.79
950.00				5.377	6.105	2.47	2.775	3.102	1.89
1,000.00				5.925	6.744	2.60	3.056	3.425	1.99
1,050.00				6.500	7.415	2.73	3.351	3.764	2.09
1,100.00				7.099	8.118	2.86	3.658	4.119	2.19
1,150.00				7.725	8.853	2.99	3.978	4.490	2.29
1,200.00							4.312	4.876	2.39
1,250.00							4.658	5.278	2.49
1,300.00							5.017	5.696	2.59
1,350.00							5.389	6.130	2.69
1,400.00							5.774	6.579	2.79
1,450.00							6.172	7.045	2.88

Figures directly applicable for water at 10°C

* Head (in meters) of the fluid as it flows through a standard kilometer of the pipe.

WATER CYCLE

Head losses (tables)

Q (L/s)	DN 900			DN 1000			DN 1100		
	j (m/km)*		V (m/s)	j (m/km)*		V (m/s)	j (m/km)*		V (m/s)
	k = 0.03 m	k = 0.10 mm		k = 0.03 m	k = 0.10 mm		k = 0.03 m	k = 0.10 mm	
340.00	0.231	0.244	0.53						
360.00	0.257	0.272	0.57						
380.00	0.284	0.301	0.60						
400.00	0.312	0.331	0.63	0.187	0.197	0.51			
420.00	0.341	0.363	0.66	0.204	0.215	0.53			
440.00	0.372	0.396	0.69	0.222	0.235	0.56			
460.00	0.403	0.431	0.72	0.241	0.255	0.59			
480.00	0.436	0.467	0.75	0.261	0.277	0.61	0.164	0.173	0.51
500.00	0.470	0.504	0.79	0.281	0.299	0.64	0.177	0.186	0.53
520.00	0.506	0.543	0.82	0.303	0.322	0.66	0.190	0.201	0.55
540.00	0.542	0.583	0.85	0.324	0.345	0.69	0.204	0.215	0.57
560.00	0.580	0.625	0.88	0.347	0.370	0.71	0.218	0.231	0.59
580.00	0.619	0.668	0.91	0.370	0.395	0.74	0.233	0.246	0.61
600.00	0.659	0.712	0.94	0.394	0.421	0.76	0.248	0.262	0.63
620.00	0.701	0.758	0.97	0.419	0.448	0.79	0.263	0.279	0.65
640.00	0.743	0.805	1.01	0.444	0.476	0.81	0.279	0.296	0.67
660.00	0.787	0.853	1.04	0.470	0.504	0.84	0.295	0.314	0.69
680.00	0.832	0.903	1.07	0.497	0.534	0.87	0.312	0.332	0.72
700.00	0.878	0.955	1.10	0.524	0.564	0.89	0.329	0.351	0.74
720.00	0.925	1.007	1.13	0.552	0.595	0.92	0.347	0.370	0.76
740.00	0.974	1.061	1.16	0.581	0.627	0.94	0.365	0.390	0.78
760.00	1.023	1.117	1.19	0.610	0.659	0.97	0.383	0.410	0.80
780.00	1.074	1.174	1.23	0.641	0.693	0.99	0.402	0.431	0.82
800.00	1.126	1.232	1.26	0.671	0.727	1.02	0.421	0.452	0.84
850.00	1.261	1.383	1.34	0.752	0.816	1.08	0.471	0.507	0.89
900.00	1.403	1.544	1.41	0.836	0.910	1.15	0.524	0.565	0.95
950.00	1.552	1.712	1.49	0.925	1.008	1.21	0.579	0.626	1.00
1,000.00	1.709	1.890	1.57	1.017	1.112	1.27	0.637	0.690	1.05
1,050.00	1.872	2.076	1.65	1.114	1.221	1.34	0.698	0.757	1.10
1,100.00	2.043	2.270	1.73	1.216	1.335	1.40	0.761	0.828	1.16
1,150.00	2.221	2.473	1.81	1.321	1.454	1.46	0.827	0.901	1.21
1,200.00	2.406	2.685	1.89	1.431	1.578	1.53	0.895	0.977	1.26
1,250.00	2.599	2.905	1.96	1.545	1.707	1.59	0.966	1.057	1.32
1,300.00	2.798	3.134	2.04	1.663	1.840	1.66	1.040	1.139	1.37
1,350.00	3.004	3.372	2.12	1.785	1.979	1.72	1.116	1.225	1.42
1,400.00	3.218	3.618	2.20	1.911	2.123	1.78	1.194	1.313	1.47
1,450.00	3.438	3.872	2.28	2.041	2.272	1.85	1.276	1.405	1.53
1,500.00	3.666	4.135	2.36	2.176	2.425	1.91	1.359	1.499	1.58
1,550.00	3.901	4.407	2.44	2.314	2.584	1.97	1.446	1.597	1.63
1,600.00	4.142	4.687	2.52	2.457	2.748	2.04	1.534	1.698	1.68
1,650.00	4.391	4.976	2.59	2.604	2.916	2.10	1.626	1.801	1.74
1,700.00	4.647	5.274	2.67	2.755	3.090	2.16	1.720	1.908	1.79
1,750.00	4.909	5.580	2.75	2.910	3.268	2.23	1.816	2.018	1.84
1,800.00	5.179	5.894	2.83	3.069	3.452	2.29	1.915	2.131	1.89
1,850.00	5.456	6.217	2.91	3.232	3.640	2.36	2.016	2.247	1.95
1,900.00	5.739	6.549	2.99	3.400	3.834	2.42	2.120	2.365	2.00
1,950.00				3.571	4.032	2.48	2.227	2.487	2.05
2,000.00				3.747	4.235	2.55	2.336	2.612	2.10
2,100.00				4.110	4.657	2.67	2.561	2.871	2.21
2,200.00				4.489	5.098	2.80	2.797	3.142	2.31
2,300.00				4.885	5.559	2.93	3.042	3.425	2.42
2,400.00							3.298	3.720	2.53
2,500.00							3.563	4.028	2.63
2,600.00							3.838	4.347	2.74
2,700.00							4.124	4.679	2.84
2,800.00							4.419	5.022	2.95

Figures directly applicable for water at 10°C

* Head (in meters) of the fluid as it flows through a standard kilometer of the pipe.

WATER CYCLE

Head losses (tables)

Q (L/s)	DN 1200			DN 1400			DN 1500		
	j (m/km)*		V (m/s)	j (m/km)*		V (m/s)	j (m/km)*		V (m/s)
	k = 0.03 m	k = 0.10 mm		k = 0.03 m	k = 0.10 mm		k = 0.03 m	k = 0.10 mm	
600.00	0.162	0.171	0.53						
650.00	0.188	0.198	0.57						
700.00	0.215	0.228	0.62						
750.00	0.244	0.259	0.66						
800.00	0.275	0.293	0.71	0.130	0.137	0.52			
850.00	0.308	0.329	0.75	0.145	0.153	0.55			
900.00	0.342	0.366	0.80	0.161	0.170	0.58	0.115	0.121	0.51
950.00	0.379	0.406	0.84	0.178	0.189	0.62	0.128	0.134	0.54
1,000.00	0.416	0.447	0.88	0.196	0.208	0.65	0.140	0.148	0.57
1,050.00	0.456	0.490	0.93	0.215	0.228	0.68	0.153	0.162	0.59
1,100.00	0.497	0.536	0.97	0.234	0.249	0.71	0.167	0.177	0.62
1,150.00	0.540	0.583	1.02	0.254	0.270	0.75	0.181	0.192	0.65
1,200.00	0.584	0.632	1.06	0.275	0.293	0.78	0.196	0.208	0.68
1,250.00	0.630	0.683	1.11	0.296	0.317	0.81	0.212	0.225	0.71
1,300.00	0.678	0.736	1.15	0.319	0.341	0.84	0.228	0.242	0.74
1,350.00	0.728	0.791	1.19	0.342	0.366	0.88	0.244	0.260	0.76
1,400.00	0.779	0.848	1.24	0.366	0.392	0.91	0.261	0.278	0.79
1,450.00	0.831	0.907	1.28	0.390	0.420	0.94	0.279	0.297	0.82
1,500.00	0.886	0.968	1.33	0.416	0.447	0.97	0.297	0.317	0.85
1,550.00	0.942	1.031	1.37	0.442	0.476	1.01	0.315	0.338	0.88
1,600.00	0.999	1.096	1.41	0.469	0.506	1.04	0.334	0.359	0.91
1,650.00	1.059	1.162	1.46	0.496	0.536	1.07	0.354	0.380	0.93
1,700.00	1.120	1.231	1.50	0.525	0.568	1.10	0.374	0.402	0.96
1,750.00	1.182	1.301	1.55	0.554	0.600	1.14	0.395	0.425	0.99
1,800.00	1.246	1.374	1.59	0.584	0.633	1.17	0.416	0.449	1.02
1,850.00	1.312	1.448	1.64	0.615	0.667	1.20	0.438	0.473	1.05
1,900.00	1.380	1.524	1.68	0.646	0.702	1.23	0.460	0.497	1.08
1,950.00	1.449	1.603	1.72	0.678	0.738	1.27	0.483	0.522	1.10
2,000.00	1.519	1.683	1.77	0.711	0.775	1.30	0.507	0.548	1.13
2,100.00	1.665	1.849	1.86	0.779	0.851	1.36	0.555	0.602	1.19
2,200.00	1.818	2.023	1.95	0.850	0.930	1.43	0.605	0.658	1.24
2,300.00	1.977	2.204	2.03	0.924	1.013	1.49	0.658	0.716	1.30
2,400.00	2.142	2.394	2.12	1.001	1.099	1.56	0.712	0.777	1.36
2,500.00	2.314	2.591	2.21	1.080	1.189	1.62	0.769	0.841	1.41
2,600.00	2.492	2.795	2.30	1.163	1.283	1.69	0.828	0.906	1.47
2,700.00	2.677	3.008	2.39	1.248	1.379	1.75	0.888	0.974	1.53
2,800.00	2.867	3.228	2.48	1.337	1.480	1.82	0.951	1.045	1.58
2,900.00	3.065	3.456	2.56	1.428	1.583	1.88	1.016	1.118	1.64
3,000.00	3.268	3.691	2.65	1.522	1.691	1.95	1.083	1.194	1.70
3,100.00	3.478	3.934	2.74	1.620	1.801	2.01	1.152	1.271	1.75
3,200.00	3.694	4.185	2.83	1.720	1.915	2.08	1.223	1.352	1.81
3,300.00	3.917	4.444	2.92	1.823	2.033	2.14	1.296	1.435	1.87
3,400.00				1.928	2.154	2.21	1.371	1.520	1.92
3,500.00				2.037	2.279	2.27	1.448	1.607	1.98
3,650.00				2.206	2.472	2.37	1.567	1.743	2.07
3,800.00				2.380	2.673	2.47	1.691	1.885	2.15
3,950.00				2.562	2.882	2.57	1.819	2.032	2.24
4,100.00				2.750	3.099	2.66	1.952	2.184	2.32
4,250.00				2.944	3.323	2.76	2.090	2.342	2.41
4,400.00				3.144	3.555	2.86	2.232	2.505	2.49
4,550.00				3.351	3.795	2.96	2.379	2.674	2.57
4,700.00							2.530	2.848	2.66
4,850.00							2.685	3.027	2.74
5,000.00							2.845	3.212	2.83
5,150.00							3.010	3.403	2.91
5,300.00							3.179	3.599	3.00

Figures directly applicable for water at 10°C

* Head (in meters) of the fluid as it flows through a standard kilometer of the pipe.

WATER CYCLE

Head losses (tables)

Q (L/s)	DN 1600			DN 1800			DN 2000		
	j (m/km)*		V (m/s)	j (m/km)*		V (m/s)	j (m/km)*		V (m/s)
	k = 0.03 m	k = 0.10 mm		k = 0.03 m	k = 0.10 mm		k = 0.03 m	k = 0.10 mm	
1,100.00	0.122	0.128	0.55						
1,200.00	0.143	0.151	0.60						
1,300.00	0.166	0.176	0.65	0.094	0.098	0.51			
1,400.00	0.190	0.202	0.70	0.107	0.113	0.55			
1,500.00	0.216	0.230	0.75	0.122	0.128	0.59			
1,600.00	0.244	0.260	0.80	0.137	0.145	0.63	0.082	0.086	0.51
1,700.00	0.273	0.292	0.85	0.154	0.162	0.67	0.092	0.096	0.54
1,800.00	0.304	0.325	0.90	0.171	0.181	0.71	0.102	0.107	0.57
1,900.00	0.336	0.360	0.94	0.189	0.200	0.75	0.113	0.119	0.60
2,000.00	0.369	0.397	0.99	0.208	0.221	0.79	0.124	0.131	0.64
2,100.00	0.404	0.436	1.04	0.227	0.242	0.83	0.136	0.144	0.67
2,200.00	0.441	0.476	1.09	0.248	0.265	0.86	0.148	0.157	0.70
2,300.00	0.479	0.518	1.14	0.269	0.288	0.90	0.161	0.170	0.73
2,400.00	0.519	0.562	1.19	0.291	0.312	0.94	0.174	0.185	0.76
2,500.00	0.560	0.608	1.24	0.314	0.337	0.98	0.188	0.200	0.80
2,600.00	0.603	0.655	1.29	0.338	0.364	1.02	0.202	0.215	0.83
2,700.00	0.647	0.705	1.34	0.363	0.391	1.06	0.216	0.231	0.86
2,800.00	0.692	0.755	1.39	0.388	0.419	1.10	0.232	0.247	0.89
2,900.00	0.739	0.808	1.44	0.414	0.448	1.14	0.247	0.265	0.92
3,000.00	0.788	0.863	1.49	0.441	0.478	1.18	0.263	0.282	0.95
3,100.00	0.838	0.919	1.54	0.469	0.509	1.22	0.280	0.300	0.99
3,200.00	0.889	0.977	1.59	0.498	0.540	1.26	0.297	0.319	1.02
3,300.00	0.942	1.036	1.64	0.528	0.573	1.30	0.315	0.338	1.05
3,400.00	0.997	1.097	1.69	0.558	0.607	1.34	0.333	0.358	1.08
3,500.00	1.053	1.161	1.74	0.589	0.642	1.38	0.351	0.379	1.11
3,650.00	1.139	1.258	1.82	0.637	0.696	1.43	0.380	0.410	1.16
3,800.00	1.229	1.360	1.89	0.687	0.752	1.49	0.409	0.443	1.21
3,950.00	1.322	1.466	1.96	0.739	0.810	1.55	0.440	0.477	1.26
4,100.00	1.418	1.576	2.04	0.793	0.870	1.61	0.472	0.512	1.31
4,250.00	1.518	1.689	2.11	0.848	0.932	1.67	0.505	0.549	1.35
4,400.00	1.621	1.806	2.19	0.906	0.997	1.73	0.539	0.587	1.40
4,550.00	1.727	1.928	2.26	0.965	1.063	1.79	0.574	0.626	1.45
4,700.00	1.836	2.053	2.34	1.025	1.132	1.85	0.610	0.666	1.50
4,850.00	1.949	2.182	2.41	1.088	1.203	1.91	0.647	0.707	1.54
5,000.00	2.065	2.315	2.49	1.152	1.276	1.96	0.685	0.750	1.59
5,200.00	2.224	2.498	2.59	1.241	1.376	2.04	0.737	0.809	1.66
5,400.00	2.390	2.689	2.69	1.333	1.481	2.12	0.792	0.870	1.72
5,600.00	2.561	2.886	2.79	1.428	1.589	2.20	0.848	0.933	1.78
5,800.00	2.737	3.090	2.88	1.526	1.701	2.28	0.906	0.999	1.85
6,000.00	2.920	3.301	2.98	1.627	1.816	2.36	0.966	1.066	1.91
6,200.00				1.731	1.936	2.44	1.027	1.136	1.97
6,400.00				1.839	2.059	2.52	1.091	1.208	2.04
6,600.00				1.949	2.186	2.59	1.156	1.282	2.10
6,800.00				2.063	2.317	2.67	1.223	1.359	2.16
7,000.00				2.180	2.451	2.75	1.292	1.437	2.23
7,200.00				2.300	2.589	2.83	1.363	1.518	2.29
7,400.00				2.423	2.731	2.91	1.436	1.601	2.36
7,600.00				2.549	2.877	2.99	1.510	1.686	2.42
7,800.00							1.587	1.773	2.48
8,000.00							1.665	1.863	2.55
8,200.00							1.745	1.954	2.61
8,400.00							1.826	2.048	2.67
8,600.00							1.910	2.144	2.74
8,800.00							1.995	2.242	2.80
9,000.00							2.083	2.343	2.86
9,200.00							2.171	2.445	2.93
9,400.00							2.262	2.550	2.99

Figures directly applicable for water at 10°C

* Head (in meters) of the fluid as it flows through a standard kilometer of the pipe.

WATER CYCLE

BLUTOP® head losses (tables)

Q (L/s)	BLUTOP® DN 75		ID	BLUTOP® DN 90		ID	BLUTOP® DN 110		ID
	j (m/km)*		68	j (m/km)*		83	j (m/km)*		103
	0.01	0.05	V (m/s)	0.01	0.05	V (m/s)	0.01	0.05	V (m/s)
1.60									
1.80	4.55	4.80	0.50						
2.00	5.49	5.82	0.55						
2.20	6.50	6.92	0.61						
2.40	7.59	8.10	0.66						
2.60	8.76	9.38	0.72						
2.80	10.00	10.74	0.77	3.84	4.05	0.52			
3.00	11.31	12.20	0.83	4.34	4.59	0.55			
3.20	12.69	13.73	0.88	4.87	5.16	0.59			
3.40	14.15	15.36	0.94	5.43	5.77	0.63			
3.60	15.68	17.07	0.99	6.01	6.40	0.67			
3.80	17.28	18.86	1.05	6.62	7.07	0.70			
4.00	18.95	20.75	1.10	7.26	7.76	0.74			
4.20	20.69	22.71	1.16	7.92	8.49	0.78	2.81	2.95	0.50
4.40	22.51	24.76	1.21	8.61	9.25	0.81	3.05	3.21	0.53
4.60	24.39	26.90	1.27	9.32	10.04	0.85	3.30	3.48	0.55
4.80	26.33	29.12	1.32	10.06	10.85	0.89	3.56	3.76	0.58
5.00	28.35	31.43	1.38	10.83	11.70	0.92	3.83	4.05	0.60
5.20	30.44	33.82	1.43	11.62	12.58	0.96	4.11	4.35	0.62
5.40	32.59	36.30	1.49	12.44	13.49	1.00	4.40	4.67	0.65
5.60	34.81	38.86	1.54	13.28	14.43	1.04	4.69	4.99	0.67
5.80	37.10	41.51	1.60	14.14	15.41	1.07	5.00	5.32	0.70
6.00	39.45	44.24	1.65	15.04	16.41	1.11	5.31	5.66	0.72
6.20	41.87	47.05	1.71	15.95	17.44	1.15	5.63	6.01	0.74
6.40	44.36	49.95	1.76	16.89	18.50	1.18	5.96	6.37	0.77
6.60	46.91	52.93	1.82	17.86	19.59	1.22	6.30	6.74	0.79
6.80	49.53	56.00	1.87	18.85	20.71	1.26	6.65	7.12	0.82
7.00	52.22	59.15	1.93	19.86	21.86	1.29	7.01	7.52	0.84
7.20	54.97	62.38	1.98	20.90	23.04	1.33	7.37	7.92	0.86
7.40	57.78	65.70	2.04	21.97	24.25	1.37	7.74	8.33	0.89
7.60	60.67	69.10	2.09	23.05	25.49	1.40	8.12	8.75	0.91
7.80	63.61	72.58	2.15	24.17	26.76	1.44	8.51	9.18	0.94
8.00	66.62	76.15	2.20	25.30	28.06	1.48	8.91	9.62	0.96
8.20	69.70	79.81	2.26	26.46	29.39	1.52	9.32	10.07	0.98
8.40	72.84	83.54	2.31	27.65	30.75	1.55	9.73	10.53	1.01
8.60	76.04	87.36	2.37	28.85	32.14	1.59	10.15	11.00	1.03
8.80	79.31	91.27	2.42	30.08	33.56	1.63	10.58	11.48	1.06
9.00	82.65	95.25	2.48	31.34	35.01	1.66	11.02	11.97	1.08
9.20	86.04	99.32	2.53	32.62	36.49	1.70	11.47	12.47	1.10
9.40	89.51	103.48	2.59	33.92	38.00	1.74	11.92	12.97	1.13
9.60	93.03	107.72	2.64	35.25	39.54	1.77	12.38	13.49	1.15
9.80	96.62	112.04	2.70	36.59	41.10	1.81	12.85	14.02	1.18
10.00	100.27	116.44	2.75	37.97	42.70	1.85	13.33	14.56	1.20
10.50	109.68	127.82	2.89	41.50	46.82	1.94	14.57	15.95	1.26
11.00				45.18	51.13	2.03	15.85	17.39	1.32
11.50				49.00	55.62	2.13	17.18	18.90	1.38
12.00				52.97	60.30	2.22	18.56	20.47	1.44
12.50				57.08	65.16	2.31	19.99	22.10	1.50
13.00				61.34	70.21	2.40	21.47	23.79	1.56
13.50				65.74	75.44	2.50	22.99	25.54	1.62
14.00				70.27	80.85	2.59	24.57	27.35	1.68
14.50				74.95	86.45	2.68	26.19	29.22	1.74
16.50							33.16	37.30	1.98
18.50							40.89	46.33	2.22
20.50							49.37	56.32	2.46
22.50							58.59	67.27	2.70
24.50							68.54	79.16	2.94

Figures directly applicable for water at 10°C

* Head (in meters) of the fluid as it flows through a standard kilometer of the pipe.

WATER CYCLE

BLUTOP® head losses (tables)

Q (L/s)	BLUTOP® DN 125			BLUTOP® DN 140			BLUTOP® DN 160		
	j (m/km)*		ID 118	j (m/km)*		ID 133	j (m/km)*		ID 152
	0.01	0.05	V (m/s)	0.01	0.05	V (m/s)	0.01	0.05	V (m/s)
5.50	2.37	2.48	0.50						
6.00	2.76	2.91	0.55						
6.5	3.19	3.37	0.59						
7.00	3.64	3.86	0.64	2.12	2.23	0.51			
7.50	4.12	4.38	0.69	2.40	2.53	0.55			
8.00	4.63	4.93	0.73	2.70	2.84	0.58			
8.50	5.16	5.51	0.78	3.01	3.18	0.62			
9.00	5.72	6.12	0.82	3.33	3.53	0.66	1.69	1.77	0.50
9.50	6.30	6.76	0.87	3.67	3.90	0.69	1.86	1.95	0.52
10.00	6.91	7.43	0.91	4.03	4.28	0.73	2.04	2.15	0.55
10.50	7.55	8.14	0.96	4.40	4.68	0.77	2.23	2.35	0.58
11.00	8.21	8.87	1.01	4.78	5.10	0.80	2.42	2.55	0.61
11.50	8.90	9.63	1.05	5.18	5.54	0.84	2.63	2.77	0.63
12.00	9.61	10.42	1.10	5.59	5.99	0.88	2.83	3.00	0.66
12.50	10.35	11.25	1.14	6.02	6.46	0.91	3.05	3.23	0.69
13.00	11.11	12.10	1.19	6.46	6.95	0.95	3.27	3.47	0.72
13.50	11.90	12.98	1.23	6.92	7.45	0.99	3.50	3.72	0.74
14.00	12.71	13.90	1.28	7.39	7.97	1.02	3.74	3.98	0.77
14.50	13.55	14.84	1.33	7.88	8.51	1.06	3.99	4.25	0.80
15.00	14.41	15.81	1.37	8.37	9.07	1.10	4.24	4.52	0.83
15.50	15.29	16.81	1.42	8.89	9.64	1.13	4.50	4.80	0.85
16.00	16.20	17.84	1.46	9.41	10.22	1.17	4.76	5.09	0.88
16.50	17.13	18.91	1.51	9.95	10.83	1.21	5.03	5.39	0.91
17.00	18.09	20.00	1.55	10.51	11.45	1.24	5.31	5.70	0.94
17.50	19.07	21.12	1.60	11.08	12.09	1.28	5.60	6.01	0.96
18.00	20.08	22.27	1.65	11.66	12.74	1.32	5.89	6.34	0.99
18.50	21.11	23.45	1.69	12.25	13.41	1.35	6.19	6.67	1.02
19.00	22.16	24.66	1.74	12.86	14.10	1.39	6.50	7.01	1.05
19.50	23.24	25.89	1.78	13.48	14.80	1.42	6.81	7.35	1.07
20.00	24.34	27.16	1.83	14.12	15.52	1.46	7.13	7.71	1.10
20.50	25.46	28.46	1.87	14.77	16.26	1.50	7.46	8.07	1.13
21.00	26.61	29.79	1.92	15.43	17.01	1.53	7.79	8.44	1.16
21.50	27.78	31.14	1.97	16.11	17.78	1.57	8.13	8.82	1.18
22.00	28.97	32.53	2.01	16.80	18.57	1.61	8.48	9.21	1.21
22.50	30.19	33.94	2.06	17.50	19.37	1.64	8.83	9.60	1.24
23.00	31.43	35.39	2.10	18.22	20.19	1.68	9.19	10.00	1.27
23.50	32.69	36.86	2.15	18.95	21.03	1.72	9.56	10.41	1.30
24.00	33.98	38.36	2.19	19.69	21.88	1.75	9.93	10.83	1.32
26.00	39.36	44.67	2.38	22.80	25.45	1.90	11.49	12.59	1.43
28.00	45.11	51.45	2.56	26.11	29.28	2.05	13.15	14.47	1.54
30.00	51.22	58.69	2.74	29.63	33.38	2.19	14.92	16.48	1.65
32.00	57.69	66.40	2.93	33.36	37.74	2.34	16.79	18.61	1.76
34.00				37.30	42.36	2.48	18.76	20.87	1.87
36.00				41.44	47.24	2.63	20.83	23.25	1.98
38.00				45.79	52.38	2.78	23.00	25.77	2.09
40.00				50.33	57.78	2.92	25.27	28.40	2.20
42.00							27.65	31.16	2.31
44.00							30.12	34.05	2.42
46.00							32.69	37.06	2.54
48.00							35.36	40.20	2.65
50.00							38.12	43.46	2.76

Figures directly applicable for water at 10°C

* Head (in meters) of the fluid as it flows through a standard kilometer of the pipe.

PRESSURE AND ANGULAR DEVIATION AT THE JOINT

Pressures (terminology)

With the term “pressure”, a distinction needs to be made between the terminology used by the:

- Network designer (related to the system)
- Manufacturer (related to product performance)
- System user (related to the service)

Terminology

The terminology listed below is based on European standard EN 805 – Water supply – Requirements for systems and components outside buildings – applicable to all materials.

	Terminology			
	Abbreviation	French	English	German
Designer	DP	pression de calcul en régime permanent	design pressure	Systembetriebsdruck
	MDP	pression maximale de calcul	maximum design pressure	höchster Systembetriebsdruck
	STP	pression d'épreuve du réseau	system test pressure	Systemprüfdruck
Manufacturer	PFA	pression de fonctionnement admissible	allowable operating pressure	zulässiger Bauteilbetriebsdruck
	PMA	pression maximale admissible	allowable maximum operating pressure	höchster zulässigen Bauteilbetriebsdruck
	PEA	pression d'épreuve admissible	allowable test pressure	zulässiger Bauteilprüfdruck
User	OP	pression de fonctionnement	operating pressure	Betriebsdruck
	SP	pression de service	service pressure	Versorgungsdruck

The EN 545 standard (Ductile iron pipes, fittings, accessories and their joints for water pipelines) uses the same manufacturer-related terminology.

PRESSURE AND ANGULAR DEVIATION AT THE JOINT

Pressures (terminology)

Designer's terminology

DP – Design pressure

Maximum operating pressure of the system or of the pressure zone fixed by the designer considering future developments but excluding surge.

MDP – Maximum design pressure

Maximum operating pressure of the system or of the pressure zone fixed by the designer considering future developments and including surge.

MDP is designated **MDPa** when there is a fixed allowance for surge.

MDP is designated **MDPc** when the surge is calculated.

STP – System test pressure

Hydrostatic pressure applied to a newly laid pipeline in order to ensure its integrity and tightness.

Manufacturer's terminology (applicable to this catalog)

PFA – Allowable operating pressure

Maximum hydrostatic pressure that a component is capable of withstanding continuously in service. This is the pressure at which the system is capable of operating continuously.

PMA – Allowable maximum operating pressure

Maximum pressure occurring from time to time, including surge, that a component is capable of withstanding in service. This is the pressure at which the system is capable of operating continuously, including surge.

In case of ductile iron pipes, $PMA = 1.2 \times PFA$, measured in bar (according to EN 545).

PEA – Allowable test pressure

Maximum hydrostatic pressure that a newly installed component is capable of withstanding. This is the pressure at which the system is capable of operating continuously for a relatively short duration in order to ensure the integrity and tightness of the pipeline.

In case of ductile iron pipes, $PEA = PMA + 5 = 1.2 \times PFA + 5$, measured in bar (according to EN 545).

User's terminology

OP – Operating pressure

Internal pressure which occurs at a particular time and at a particular point in the water supply system.

PRESSURE AND ANGULAR DEVIATION AT THE JOINT

Pressures (terminology)

SP – Service pressure

Internal pressure delivered at the point of connection to the consumer's installation at zero flow in the service pipe.

Other manufacturer's definitions

PN – Nominal pressure (according to EN 545)

Numerical designation, which is a convenient rounded number, used for reference purposes. All components of the same nominal size DN designated by the same PN number have compatible mating dimensions.

EN 545 – Annex A.4, Table A.2 – specifies the following PN equivalents in PFA, PMA and PEA for flanged pipes and fittings:

DN	PN 10			PN 16			PN 25			PN 40		
	PFA	PMA	PEA	PFA	PMA	PEA	PFA	PMA	PEA	PFA	PMA	PEA
40 to 50	See PN 40			See PN 40			See PN 40			40	48	53
60 to 80	See PN 16			16	20	25	See PN 40			40	48	53
100 to 150	See PN 16			16	20	25	25	30	35	40	48	53
200 to 300	10	12	17	16	20	25	25	30	35	40	48	53
350 to 1 200	10	12	17	16	20	25	25	30	35	–	–	–
1 400 to 2 000	10	12	17	16	20	25	–	–	–	–	–	–
For DN 80 flanged parts manufactured by PAM , use the following equivalents:												
80	See PN 40			See PN 40			See PN 40			40	48	53

Leaktightness test pressure (according to EN 545)

Pressure applied to a component during manufacture to ensure its leaktightness.

PRESSURE AND ANGULAR DEVIATION AT THE JOINT

Allowable operating pressure for pipes and fittings (bar)

PAM pipelines are designed to withstand high pressures, generally far higher than the values usually encountered in the networks. This is justified by the need to withstand the numerous stresses to which pipelines are subjected during installation and especially during their service life.

Pipeline design calculation

When choosing a pipeline component, ensure that the three inequalities opposite are respected.

Where:

DP	= Design pressure
MDP	= Maximum design pressure
STP	= System test pressure

Safety factor

$DP \leq PFA$
$MDP \leq PMA$
$STP \leq PEA$

The pressures indicated in the following tables were produced using high safety factors that not only take into account the forces due to the internal pressure but also the many other accidental stresses to which pipelines are sometimes subjected during installation and when in service.

Example: the PFA of a pipe is calculated with a safety factor of:

- 3 with respect to the minimum tensile strength
- 2 with respect to the minimum elastic limit

Using the pressure table

The pressure resistance of a component depends on the:

- Strength of the component body
- Performance of the joint(s) fitted

When mating two components, take account of the resistance of the weakest component.

For each type of component (pipes, fittings, etc.) and each type of joint, the following tables provide the applicable PFA, PMA and PEA values.

If a pipe is equipped with two types of joint (one at each end), choose the lowest PFA, PMA and PEA values.

If a pipe is equipped with two types of joint (e.g. double socket tee with a flanged branch), choose the lowest PFA, PMA and PEA values.

Example: DN 300 tee with 2 EXPRESS sockets and flanged branch DN 150 PN 40, Class C50:

PFA	= 40
PMA	= 48
PEA	= 53

PRESSURE AND ANGULAR DEVIATION AT THE JOINT

Allowable operating pressure for pipes and fittings (bar)



STANDARD JOINT

STD			NATURAL	NATURAL PUR	NATURAL superior class	IRRIGAL	URBITAL	ISOPAM	TT PE	PUX PUR	MINERAL
DN	class	PFA									
60	C40	40			64 (C64)						
80	C40	40			64 (C64)						
100	C40	40			64 (C64)						
125	C40	40			64 (C64)						
150	C40	40			64 (C64)						
200	C40	40			50 (C50)						
250	C40	40			50 (C50)						
300	C40	40			50 (C50)						
350	C30	30			40 (C40)						
400	C30	30			40 (C40)						
450	C30	30			40 (C40)						
500	C30	30			40 (C40)						
600	C30	30			40 (C40)						
700	C25	25									
700	C30	30									
800	C25	25									
800	C30	30									
900	C25	25									
900	C30	30									
1000	C25	25									
1000	C30	30									
1100	C25	25									
1100	C30	30									
1200	C25	25									
1200	C30	30									
1400	C25	25									
1500	C25	25									
1600	C25	25									
1800	C25	25									
2000	C25	25									

These PFA values also apply to the Standard joint fittings in the table below.

Fitting pressure classes

DN	Class	DN	Class
DN 60 to DN 100	C100	DN 400 to DN 600	C40
DN 125 to DN 200	C64	DN 700 to DN 1400	C30
DN 250 to DN 350	C50	DN 1500 to DN 2000	C25

For more information about the ranges, visit: <http://www.pamline.com>

PRESSURE AND ANGULAR DEVIATION AT THE JOINT

Allowable operating pressure for pipes and fittings (bar)



STANDARD Vi JOINT

STD Vi			NATURAL	NATURAL PUR	NATURAL HPVi	IRRIGAL	URBITAL	ISOPAM	FM	TT PE	MINERAL
DN	class	PFA									
60	C40	22			30 (C64)						
80	C40	16			25 (C64)						
100	C40	16			25 (C64)						
125	C40	16			20 (C64)						
150	C40	16			25 (C64)						
200	C40	16			20 (C50)						
250	C40	16			20 (C50)						
300	C40	16			20 (C50)						
350	C30	16			20 (C40)						
400	C30	16			20 (C40)						
450	C30	13			20 (C40)						
500	C30	11			18 (C40)						
600	C30	10			16 (C40)						
700	C25	10			NC						



UNIVERSAL Vi JOINT

UNI Vi			NATURAL	NATURAL PUR	TT PE	MINERAL
DN	class	PFA				
80	C100	100				
100	C100	56				
125	C64	52				
150	C64	48				
200	C64	43				
250	C50	39				
300	C50	34				
350	C40	25				
400	C40	20				
450	C40	16				
500	C40	16				
600	C40	16				
700	C30	10				



UNIVERSAL Ve JOINT

UNI Ve			NATURAL	NATURAL PUR	TT PE	MINERAL
DN	class	PFA				
80	C100	100				
100	C100	85				
125	C64	63				
150	C64	63				
200	C64	63				
250	C50	50				
300	C50	41				
350	C40	38				
400	C40	35				
450	C40	32				
500	C40	30				
600	C40	30				
700	C30	27				
800	C30	25				
900	C30	25				
1000	C30	25				
1100	C30	25				
1200	C25	20				
1200	C30	25				
1400	C25	16				
1500	C25	16				
1600	C25	16				

PRESSURE AND ANGULAR DEVIATION AT THE JOINT

Allowable operating pressure for pipes and fittings (bar)



PAMLOCK JOINT

PAMLOCK			NATURAL
DN	class	PFA	
1400	C25	25	
1500	C25	25	
1600	C25	25	
1800	C25	16	
2000	C25	16	

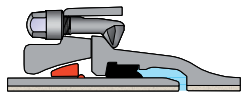

STANDARD Ve JOINT

STD Ve			NATURAL	NATURAL PUR	PUX PUR	MINERAL
DN	class	PFA				
80	C100	64				
100	C100	64				
125	C64	64				
150	C64	55				
200	C64	46				
250	C50	35				
300	C50	30				
350	C30	27				
400	C30	25				
450	C30	23				
500	C30	22				
600	C30	20				
700	C30	25				
800	C30	16/25*				
900	C30	16/25*				
1000	C30	16/25*				
1100	C25	16/25*				
1200	C25	16/20*				

*with steel bolts and bearing plates, other cast iron bolt DN sizes



STANDARD V+I JOINT only for fittings

STD V+I			NATURAL	NATURAL PUR
DN	Class	PFA		
350	C30	12		
400	C30	10		
450	C30	10		
500	C30	10		
600	C30	10		

PRESSURE AND ANGULAR DEVIATION AT THE JOINT

Allowable operating pressure for pipes and fittings (bar)

ALPINAL® range

DN	Class	TYTON UNI	TYTON UNI Vi	TYTON UNI Ve	Class	UNI STD	UNI STD VE
80	C100	100	100	100			
100	C100	100	56	85			
100	C145	145	100	100			
125	C64	63	52	63			
125	C100	100	100	100			
150	C64	63	48	63			
150	C100	100	63	100			
200	C64	63		63			
200	C100	100		100			
250	C50	50		50			
250	C85	85		78			
250	C100	100		100			
300	C50	50		41			
300	C75	75		70			
300	C85	85		80			
300	C100	100		100			
400	C100	100		85	C40	40	35
400					C64	63	63
500	C64	64			C40	40	30
500	C75	75		75	C50	50	50
500	C100	100					
600	C64	64		64			
600	C100	100					

These PFA values apply to the fittings in the ALPINAL range.

BLUTOP® range

DN	Class	Non-restrained	Restrained
75	C25	25	16
90	C25	25	16
110	C25	25	16
125	C25	25	16
140	C25	25	16
160	C25	25	16

PRESSURE AND ANGULAR DEVIATION AT THE JOINT

Allowable operating pressure for pipes and fittings (bar)

PMA and PEA according to the PFA (bar)

PFA	PMA	PEA	PFA	PMA	PEA	PFA	PMA	PEA
100	120	125	45	54	59	26	31	36
64	76	81	43	51	56	25	30	35
63	75	80	41	49	54	23	28	33
60	72	77	40	48	53	22	26	31
57	68	73	39	46	51	20	24	29
56	67	72	38	45	50	18	21	26
55	65	70	35	42	47	16	19	24
52	62	67	34	41	45	13	15	20
50	60	65	32	38	43	12	14	19
48	57	62	30	36	41	11	13	18
46	55	60	27	32	37	10	12	17

Express joint fittings

DN	Fitting C	Pipe C	Express PFA	Express Vi PFA
60	100	40	40	16
80	100	40	40	16
100	100	40	40	16
125	64	40	40	16
150	64	40	40	16
200	64	40	40	16
250	50	40	40	16
300	50	40	40	16
350	50	30	30	-
400	40	30	30	-
450	40	30	30	-
500	40	30	30	-
600	40	30	30	-
700	30	25	25	-
800	30	25	25	-
900	30	25	25	-
1 000	30	25	25	-
1 100	30	25	25	-
1 200	30	25	25	-
1 400	30	25	25	-
1 500	25	25	25	-
1 600	25	25	25	-
1 800	25	25	25	-
2 000	25	25	25	-

For fittings mounted on pipes with a higher pressure class rating, contact us.

PRESSURE AND ANGULAR DEVIATION AT THE JOINT

Anchoring

Hydraulic thrust forces occur at the location of changes in direction, reductions in diameter (bends, tees, tapered sections, etc.) and at the end of pipelines carrying pressurized fluid. These forces may lead to joint separation on the pipeline unless they are counteracted with concrete anchor blocks or anchoring devices.

Hydraulic thrust forces may be extremely high and must be counteracted using suitable anchoring devices or concrete anchor blocks.

Hydraulic thrust forces can be calculated using the following general formula:

$$F = K.P.S$$

F: thrust force (in N)

P: maximum internal pressure (site test pressure) (in Pa)

S: cross-sectional area (inside for flanged joints, outside for all other types) (in m²)

K: coefficient according to the geometry of the piping component concerned

Value of coefficient K depending on the type of fitting	
Fitting	K
Blank flange	1.000
1/4 bend	1.414
1/8 bend	0.765
1/16 bend	0.390
1/32 bend	0.196
Taper	1-S'/S (S' smallest section)
Tee	1.000

Hydraulic thrust forces occurring in a pipeline:

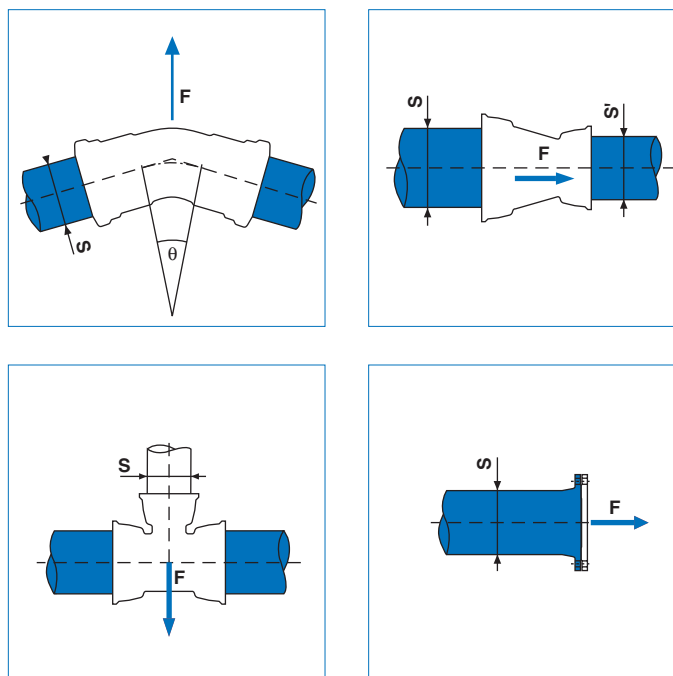

PRESSURE AND ANGULAR DEVIATION AT THE JOINT

Anchoring

Hydraulic thrust: the table below gives the thrust forces at a pressure of 1 bar.
(For other pressures, multiply by the site test pressure in bar).

DN	Thrust F in daN for 1 bar				
	1/4 bend	1/8 bend	1/16 bend	1/32 bend	Tees and blank flanges
60	66	36	18	9	47
80	106	57	29	15	75
100	154	83	43	21	109
125	230	125	64	32	163
150	321	174	89	44	227
200	547	296	151	76	387
250	834	451	230	116	590
300	1,181	639	326	164	835
350	1,587	858	438	220	1,122
400	2,043	1,105	564	283	1,445
450	2,558	1,384	706	355	1,809
500	3,143	1,701	867	436	2,223
600	4,478	2,423	1,235	621	3,167
700	6,049	3,273	1,668	838	4,278
800	7,873	4,260	2,172	1,091	5,568
900	9,918	5,366	2,735	1,375	7,014
1,000	12,197	6,599	3,364	1,691	8,626
1,100	-	7,960	4,058	2,039	10,405
1,200	17,491	9,463	4,824	2,425	12,370
1,400	-	12,842	6,547	3,290	16,787
1,500	-	14,716	7,502	3,770	19,236
1,600	-	16,716	8,522	4,283	21,851
1,800	-	21,123	10,769	5,412	27,612
2,000	-	26,044	13,278	6,673	34,045

PRESSURE AND ANGULAR DEVIATION AT THE JOINT

Anchoring

Greater freedom when designing networks

Phasing out concrete anchor blocks

Anchoring technologies are increasingly taking the place of concrete anchor blocks, which have many drawbacks due to their weight and size:

- **Footprint on construction sites**

The greater the diameter of the pipeline, the larger the anchor blocks required. This can lead to real problems, since the limited space available underground has to be shared by many different networks (such as gas, sewage, telecommunications and cable networks).

- **Trench opening time**

Best concreting practices specify a curing time of 28 days before loads can be applied. Even if this time can be shortened, it constitutes a major constraint that is no longer acceptable in urban areas.

- **Long-term risks of destabilization**

These risks may be due to natural causes, such as non-homogeneous soil or irregular ground, nearby digging for other grids and networks, especially in urban areas. These factors affect the stability and consequently the durability of concrete structures and raise the fear of ruptured joints.

- **The problems inherent in legacy systems**

Major dismantling works have to be carried out when pipelines require maintenance and later on when pipelines reach the end of their service life.

Anchoring: a modern approach to water supply systems

Anchoring solutions are gaining traction in most countries around the world. These solutions offer significant advantages:

- **Small underground footprint**

Pipelines fitted with anchoring systems take up no more space than pipelines without anchoring. This leaves adequate space for other networks, while reducing the amount of excavation material.

- **Fewer logistical constraints**

For reasons such as accessibility and cost, it is not always easy to bring in several cubic meters of concrete to make anchor blocks. Pipeline installation speed is often limited by the rotation of trucks delivering concrete. Anchoring devices are light and easy to transport to the installation site, whether in the city, the countryside or remote mountainous or desert regions.

- **Quick installation and commissioning**

Anchoring systems are extremely quick to install, especially the STANDARD Vi and EXPRESS Vi systems. In addition, they can be subjected to hydraulic testing immediately after being installed.

- **Proven stability and durability**

The operation of anchoring systems relies on a combination of their intrinsic slip-out resistance and friction with the soil. **PAM**'s recommendations on anchoring lengths take into account the type of soil and the risks of works conducted in the vicinity of the pipes. The anchoring systems receive the same level of corrosion protection as the pipes and fittings.

- **Possibility of dismantling**

Pipelines can always be dismantled with the tools supplied by **PAM**, without entailing long and extensive civil engineering work.

PRESSURE AND ANGULAR DEVIATION AT THE JOINT

Anchoring

Greater flexibility for network acceptance procedures

Pipe laying and site acceptance procedures have accelerated and reached an unprecedented level of reliability thanks to anchoring devices.

- **No need to wait for concrete to set**

Pipes are ready for pressure testing as soon as the anchoring devices have been fitted.

- **An alternative to test anchor blocks**

There is no longer any need to make test anchor blocks for testing individual pipeline segments thanks to the use of EXPRESS Vi flanged socket fittings.

- **Possibility of testing shorter segments**

Shorter lengths of pipeline can now be tested, meaning that it is easier to locate and solve any problems that may arise, while trenches can be refilled more quickly.

 anchoring devices can be tested up to their allowable test pressure (PEA) during acceptance testing.

Anchoring solutions to meet increasingly stringent installation requirements

The various anchoring solutions can be adapted to respond to even the most difficult pipe-laying situations:

- Casing pipe-laying, road crossing, tunnels, bridges
- Directional drilling or pipe bursting replacement (UNIVERSAL Ve – refer to the directional drilling brochure)
- Installation in mountainous areas, especially using the UNIVERSAL anchoring solutions adopted in the ALPINAL range (refer to the ALPINAL brochure), and also for micro-hydroelectric power plants
- Pipe-laying in poor soil or submerged ground, etc.

Anchoring and sustainable development

- Material savings: joints weighing just a few kilos can replace several tons of concrete
- Space-saving designs thanks to their small footprint
- Lower transport costs (for excavated soil and concrete)
- Time savings
- Reduced timber use, since formwork for concrete anchor blocks is no longer needed



Concrete anchor blocks are not required if anchoring systems are used.

PRESSURE AND ANGULAR DEVIATION AT THE JOINT

Calculation of anchoring lengths

What length of pipeline should be anchored?

The technique involves anchoring joints over a sufficient length on both sides of the hydraulic thrust area, such as a bend, in order to harness the soil/pipe friction forces to counteract the thrust force.

The calculation of the length to be anchored does not depend on the anchoring system used. It depends on the test pressure, the pipe diameter and the parameters shown in Figures C and D.

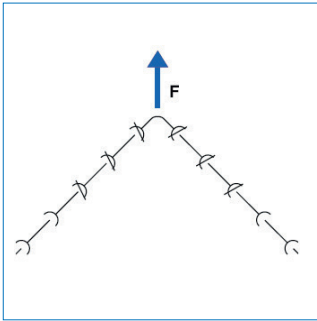

Situations for anchoring pipelines

The following formula is used to calculate the anchoring length:

$$L = \frac{PS}{Fn} \times \left(\frac{\pi - \theta}{2} \right) \times \left(\text{tg} \frac{\theta}{2} \right) \times c$$

- L: anchoring length (in m)
- P: site test pressure (in Pa)
- S: cross-sectional area (in m²)
- θ : bend angle (in radians)
- c: safety factor (generally 1.2)
- Fn: frictional force per meter of pipe (in N/m)

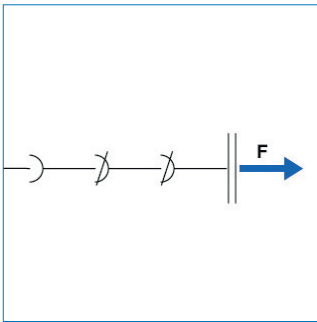

$$Fn = K.f.(2.We + Wp + Ww)$$

- Wp: weight per meter of empty pipe (in N/m)
- Ww: weight per meter of water (in N/m)
- K: coefficient of backfill pressure distribution around the pipes (depending on compacting, K = 1.1 to 1.5)
- f: coefficient of soil/pipe friction
- We: weight per meter of backfill (in N/m)

$$We = \gamma.HD\alpha_1$$

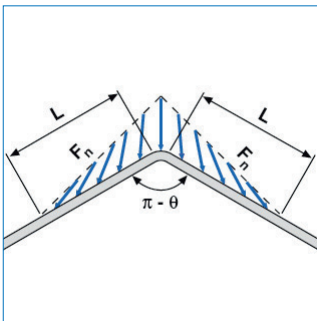

Parameters used to calculate the anchoring length

- $\alpha_1 = 1$, if testing with backfilled joints
- $\alpha_1 = 2/3$, if testing with uncovered joints
- D: pipe outside diameter (in m)
- H: height of cover (in m)

$$f = \alpha_2 . \text{tg} (0.8.\phi)$$

- $\alpha_2 = 1$; pipe with zinc or zinc-aluminum coating + bituminous or epoxy paint
- $\alpha_2 = 2/3$; TT pipe, with polyethylene or polyurethane coating, pipe with polyethylene sleeve
- $Kf = \min (K.2/3.\text{tg} (0.8\phi); 0.3)$
- ϕ : Angle of internal friction of the backfill

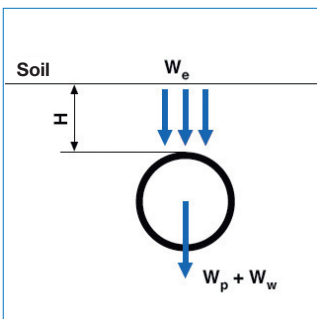

PRESSURE AND ANGULAR DEVIATION AT THE JOINT

Calculation of anchoring lengths

Assumptions	Test pressure	10 bar	Safety factor	1.5
	Soil friction angle	30°	Standard coating	(coef. 1)
	Soil density	2 t/m ³	Uncovered joints	(coef. 2/3 = 0.6667)

Anchoring lengths (in m) calculated with the above assumptions

Joint type	1/4 bend			1/8 bend			1/16 bend			1/32 bend			Blank flange or valve		
	1	1.5	2	1	1.5	2	1	1.5	2	1	1.5	2	1	1.5	2
60	4.6	3.1	2.4	2.9	1.9	1.5	1.6	1.1	0.8	0.8	0.6	0.4	5.8	4.0	3.0
80	5.8	4.0	3.0	3.6	2.5	1.9	2.0	1.4	1.0	1.1	0.7	0.6	7.4	5.0	3.8
100	7.0	4.7	3.6	4.3	2.9	2.2	2.4	1.7	1.3	1.3	0.9	0.7	8.9	6.0	4.6
125	8.4	5.8	4.4	5.2	3.6	2.7	2.9	2.0	1.5	1.6	1.1	0.8	10.7	7.3	5.6
150	9.9	6.8	5.1	6.1	4.2	3.2	3.4	2.4	1.8	1.8	1.2	0.9	12.6	8.6	6.5
200	12.7	8.7	6.7	7.9	5.4	4.1	4.4	3.0	2.3	2.3	1.6	1.2	16.2	11.1	8.5
250	15.4	10.7	8.1	9.6	6.6	5.1	5.4	3.7	2.8	2.8	2.0	1.5	19.6	13.6	10.4
300	18.0	12.5	9.6	11.2	7.8	6.0	6.3	4.4	3.3	3.3	2.3	1.8	22.9	15.9	12.2
350	20.5	14.4	11.0	12.7	8.9	6.9	7.1	5.0	3.8	3.8	2.7	2.0	26.1	18.3	14.1
400	23.0	16.1	12.4	14.3	10.0	7.7	8.0	5.6	4.3	4.2	3.0	2.3	29.3	20.5	15.8
450	25.3	17.9	13.8	15.7	11.1	8.6	8.8	6.2	4.8	4.7	3.3	2.5	32.2	22.7	17.6
500	27.6	19.6	15.2	17.2	12.2	9.4	9.6	6.8	5.3	5.1	3.6	2.8	35.2	24.9	19.3
600	31.9	22.8	17.8	19.8	14.2	11.0	11.1	8.0	6.2	5.9	4.2	3.3	40.7	29.1	22.6
700	35.6	25.7	20.2	22.1	16.0	12.5	12.4	9.0	7.0	6.6	4.8	3.7	45.3	32.8	25.7
800	39.5	28.8	22.7	24.5	17.9	14.1	13.7	10.0	7.9	7.3	5.3	4.2	50.3	36.7	28.8
900	42.9	31.6	25.0	26.7	19.6	15.5	14.9	11.0	8.7	7.9	5.8	4.6	54.6	40.2	31.8
1,000	46.4	34.4	27.3	28.9	21.4	17.0	16.2	12.0	9.5	8.6	6.3	5.0	59.1	43.8	34.8
1,100	50.5	37.5	29.8	31.4	23.3	18.5	17.6	13.1	10.4	9.3	6.9	5.5	64.4	47.8	38.0
1,200	52.7	39.6	31.7	32.8	24.6	19.7	18.4	13.8	11.0	9.7	7.3	5.8	67.1	50.4	40.3
1,400	58.8	44.6	35.9	36.5	27.7	22.3	20.5	15.5	12.5	10.9	8.2	6.6	74.8	56.8	45.7
1,500	61.4	46.8	37.9	38.1	29.1	23.5	21.4	16.3	13.2	11.3	8.7	7.0	78.2	59.6	48.2
1,600	63.9	49.1	39.8	39.7	30.5	24.7	22.3	17.1	13.9	11.8	9.1	7.3	81.4	62.5	50.7
1,800	68.8	53.3	43.5	42.7	33.1	27.0	23.9	18.6	15.1	12.7	9.8	8.0	87.6	67.9	55.4
2,000	73.0	57.2	47.0	45.4	35.5	29.2	25.4	19.9	16.3	13.5	10.6	8.7	93.0	72.8	59.8

A safety factor may be applied to the length to be anchored, depending on the:

- Laying conditions
- Quality and compaction of the backfill
- Uncertainties surrounding the physical characteristics of the backfill

Where applicable, allowance should be made for any partial presence of groundwater by correcting the weight of the full pipe by applying the corresponding Archimedes' value.

- If using a polyethylene sleeve:

Apply a multiplier of 1.9 to the length to be anchored.

- If using pipes with a polyethylene or polyurethane coating:

Apply a multiplier of 1.5 to the length to be anchored.

- Other cases: contact us.

PRESSURE AND ANGULAR DEVIATION AT THE JOINT

Anchor blocks

Concrete anchor blocks are the most commonly used technique for containing the hydraulic thrust of pressurized socket pipes.

Their use is now in sharp decline.

Principle

Various types of concrete anchor blocks can be designed, depending on the configuration of the main, the strength and type of soil, and the presence or absence of significant amounts of groundwater.

The block contains the hydraulic thrust forces:

- Either by friction on the soil
- Or by bearing against the ground

In practice, anchor blocks are designed by taking into account both the friction forces and the soil reaction against their bearing surfaces.

If the construction of concrete anchor blocks is prevented either by congestion problems or low-strength ground, the joint anchoring technologies developed by **PAM** can be used.

Refer to ANCHORING on page 39.

Sizing (usual cases)

The volumes of concrete suggested in the following tables are calculated with both the soil friction and ground bearing in mind for the most commonly encountered types of soil. If trenches subsequently need to be excavated in the vicinity of the anchor blocks, it is advisable to reduce the water pressure during work.

The design assumptions are given below. For all other cases, contact **PAM**.

□ Active forces (thrust block)

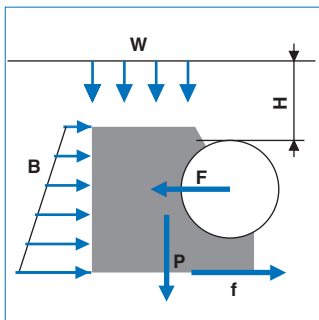

- F : hydraulic thrust
- P : block weight
- W : soil weight
- B : force bearing on trench wall
- f : friction on soil
- H : height of cover

PRESSURE AND ANGULAR DEVIATION AT THE JOINT

Anchor blocks

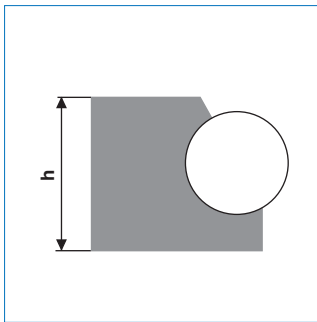

Ground

Φ : soil internal friction angle

σ : acceptable ground resistance on a vertical wall

H : height of cover: 1.20 m

γ : density

Mechanical properties:

– Table page 47: $\Phi = 30^\circ$; $\sigma \approx 0.6 \text{ daN/cm}^2$; $\gamma = 2 \text{ t/m}^3$
(moderate mechanical strength ground*)

No groundwater

* Refer to SOILS (MECHANICAL PROPERTIES) on page 54.

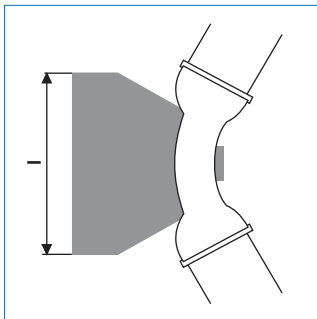

Concrete

Density: 2.3 t/m^3

Example

1/16 bend, DN 250

Test pressure: 10 bar

Height of cover: 1.2 m

Clay soil: $\Phi = 30^\circ$ $\gamma = 2 \text{ t/m}^3$

Table page 47 gives:

$l \times h = 0.70 \text{ m} \times 0.45 \text{ m}$

$V = 0.25 \text{ m}^3$

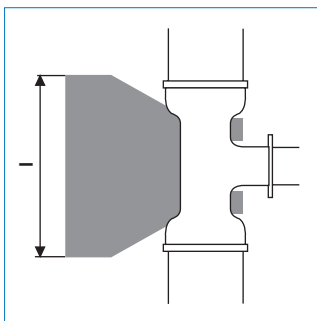

Advisory note

It is important to cast the concrete directly against the surrounding soil and use a concrete mix offering adequate strength.

When designing the anchor blocks, do not forget to leave the pipe joints exposed for inspection during subsequent hydraulic testing.

PRESSURE AND ANGULAR DEVIATION AT THE JOINT

Anchor blocks

Internal friction : $\Phi = 30^\circ$
 Strength : $\sigma \approx 0.6 \text{ daN/cm}^2$
 Density : $\gamma = 2 \text{ t/m}^3$
 Height of cover : $H = 1 \text{ m}$
 No groundwater

Moderate mechanical strength ground						
DN	Test pressure	1/32 bend l x h/V	1/16 bend l x h/V	1/8 bend l x h/V	1/4 bend l x h/V	Blank flange and tee l x h/V
	bar	m x m/m ³	m x m/m ³	m x m/m ³	m x m/m ³	m x m/m ³
60	10	0.11 x 0.16/0.01	0.14 x 0.26/0.01	0.26 x 0.26/0.03	0.46 x 0.26/0.06	0.33 x 0.26/0.03
	16	0.17 x 0.16/0.02	0.21 x 0.26/0.02	0.40 x 0.26/0.05	0.69 x 0.26/0.14	0.51 x 0.26/0.07
	25	0.17 x 0.26/0.02	0.33 x 0.26/0.03	0.60 x 0.26/0.10	1.01 x 0.26/0.29	0.75 x 0.26/0.16
80	10	0.15 x 0.18/0.02	0.20 x 0.28/0.02	0.38 x 0.28/0.05	0.65 x 0.28/0.13	0.48 x 0.28/0.07
	16	0.16 x 0.28/0.02	0.31 x 0.28/0.04	0.57 x 0.28/0.10	0.97 x 0.28/0.29	0.73 x 0.28/0.16
	25	0.25 x 0.28/0.03	0.47 x 0.28/0.07	0.84 x 0.28/0.22	1.13 x 0.38/0.53	1.06 x 0.28/0.34
100	10	0.19 x 0.20/0.04	0.26 x 0.30/0.04	0.49 x 0.30/0.08	0.84 x 0.30/0.23	0.62 x 0.30/0.13
	16	0.21 x 0.30/0.03	0.41 x 0.30/0.06	0.74 x 0.30/0.18	1.01 x 0.40/0.45	0.93 x 0.30/0.29
	25	0.33 x 0.30/0.05	0.61 x 0.30/0.12	1.08 x 0.30/0.38	1.44 x 0.40/0.92	1.10 x 0.40/0.53
125	10	0.18 x 0.33/0.03	0.35 x 0.33/0.06	0.64 x 0.33/0.15	0.90 x 0.43/0.38	0.81 x 0.33/0.24
	16	0.29 x 0.33/0.05	0.54 x 0.33/0.10	0.96 x 0.33/0.33	1.32 x 0.43/0.81	0.99 x 0.43/0.46
	25	0.43 x 0.33/0.07	0.80 x 0.33/0.23	1.15 x 0.43/0.62	1.86 x 0.43/1.61	1.42 x 0.43/0.95
150	10	0.23 x 0.35/0.04	0.44 x 0.35/0.09	0.80 x 0.35/0.25	1.12 x 0.45/0.62	0.84 x 0.45/0.35
	16	0.36 x 0.35/0.07	0.67 x 0.35/0.17	0.99 x 0.45/0.49	1.62 x 0.45/1.30	1.23 x 0.45/0.75
	25	0.54 x 0.35/0.11	0.82 x 0.45/0.33	1.42 x 0.45/1.00	2.00 x 0.55/2.41	1.54 x 0.55/1.43
200	10	0.33 x 0.40/0.08	0.62 x 0.40/0.17	0.94 x 0.50/0.49	1.38 x 0.60/1.26	1.18 x 0.50/0.76
	16	0.51 x 0.40/0.13	0.79 x 0.50/0.35	1.38 x 0.50/1.05	1.97 x 0.60/2.57	1.52 x 0.60/1.52
	25	0.64 x 0.50/0.23	1.15 x 0.50/0.73	1.74 x 0.60/2.00	2.32 x 0.80/4.74	1.94 x 0.70/2.91
250	10	0.43 x 0.45/0.14	0.69 x 0.55/0.29	1.09 x 0.65/0.85	1.63 x 0.75/2.19	1.35 x 0.65/1.31
	16	0.57 x 0.55/0.20	1.03 x 0.55/0.64	1.59 x 0.65/1.80	2.16 x 0.85/4.35	1.79 x 0.75/2.64
	25	0.84 x 0.55/0.43	1.33 x 0.65/1.26	2.04 x 0.75/3.44	2.66 x 1.05/8.18	2.32 x 0.85/5.02
300	10	0.53 x 0.50/0.22	0.85 x 0.60/0.48	1.34 x 0.70/1.39	1.87 x 0.90/3.46	1.53 x 0.80/2.06
	16	0.70 x 0.60/0.33	1.14 x 0.70/1.00	1.79 x 0.80/2.81	2.38 x 1.10/6.86	2.05 x 0.90/4.15
	25	1.03 x 0.60/0.70	1.50 x 0.80/1.99	2.21 x 1.00/5.37	3.01 x 1.30/12.92	2.38 x 1.30/8.13
350	10	0.55 x 0.65/0.22	0.92 x 0.75/0.69	1.47 x 0.85/2.03	2.10 x 1.05/5.09	1.71 x 0.95/3.04
	16	0.83 x 0.65/0.50	1.25 x 0.85/1.47	1.89 x 1.05/4.13	2.62 x 1.35/10.22	2.13 x 1.25/6.22
	25	1.11 x 0.75/1.01	1.67 x 0.95/2.93	2.34 x 1.35/8.13	3.52 x 1.35/18.40	2.81 x 1.35/11.69
400	10	0.64 x 0.70/0.31	1.06 x 0.80/0.98	1.60 x 1.00/2.82	2.18 x 1.40/7.31	1.87 x 1.10/4.24
	16	0.88 x 0.80/0.68	1.44 x 0.90/2.07	1.97 x 1.40/5.96	3.00 x 1.40/13.87	2.37 x 1.40/8.68
	25	1.19 x 0.90/1.41	1.84 x 1.10/4.09	2.68 x 1.40/11.08	4.01 x 1.40/24.73	3.21 x 1.40/15.82

For all other cases, contact 

PRESSURE AND ANGULAR DEVIATION AT THE JOINT

Safety factors

The mechanical stresses (internal pressure and external loading) to which pipelines are subjected in service can be evaluated with a high degree of accuracy. However, it is much more difficult to predict with certainty the stresses to which pipes will be subjected over time. That is why **PAM** has chosen high safety factors to maximize the service life of its ductile iron pipes.

Minimum specified safety factors

Pipes are designed to meet the requirements of the EN 545 standard:

– **Internal pressure:** the in-service stress in the pipe wall must not exceed one third of the tensile strength (which corresponds to half the elastic limit).

The minimum safety factor for calculating internal pressure is 3.

– **External load:** deformation must not result in:

- Either a stress greater than half the yield bending strength
- Or maximum vertical ovality of 4%

EN 545 recommends a maximum deformation of 4% to guarantee the resistance of the cement mortar (mainly for DN > 800).



Actual safety coefficients

The actual safety of **PAM** pipes is greater in practice than the nominal service levels (allowable operating pressure and height of cover).

$$\sigma_{Work (tensile)} \leq \frac{Rm_{(tensile)}}{3}$$

$$\sigma_{Work (tensile)} \leq \frac{Rm_{(tensile)}}{2}$$

$$\frac{\Delta D}{D} \leq 4\%$$

Accordingly:

- The material's ductility gives ductile iron pipes a high capacity to absorb work or energy beyond their actual elastic limits.
- The methods used to calculate parts are conservative and include high safety coefficients. This is clearly illustrated by the chart opposite.



Example of internal pressure safety factors

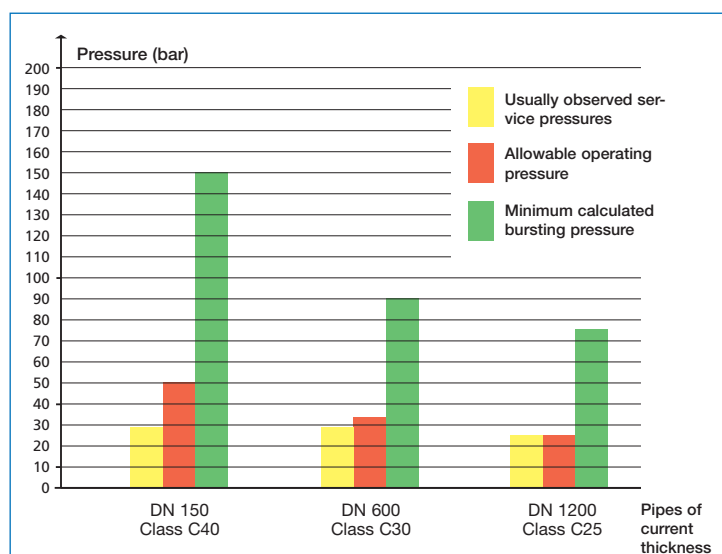

PRESSURE AND ANGULAR DEVIATION AT THE JOINT

Water hammers

When designing a pipeline, the potential risk of a water hammer or surge must be examined and quantified in order to install the necessary protection devices, particularly in pumping mains. When there are no plans to fit protection devices, ductile iron pipes have a safety coefficient that is often effective against accidental pressure surges.

Water hammer sources

If the flow rate of a liquid in a main is abruptly altered, there is a violent change in pressure. This transient problem, known as a water hammer, generally occurs when ancillary equipment is actioned or switched off (pumps, valves, etc.). Waves of pressure surges and drops sweep through the main at speed "a", which is called the wave propagation speed.

Water hammers can occur in both pumped and gravity systems. There are four main sources of water hammer:

- Pumps starting and stopping
- Closing of valves, fire and sluicing hydrants, etc.
- Presence of air
- Incorrect use of protective equipment

Consequences

In critical cases, the pressure surges involved can rupture certain pipes with inadequate safety factors. Pressure drops can create pockets of cavitation, which can damage pipes, valves and fittings.

Simplified evaluation

Wave propagation speed:
$$a = \sqrt{\frac{1}{\rho \left(\frac{1}{E} + \frac{D}{Ee} \right)}}$$

Pressure surges and drops:
$$\Delta H = \pm a \frac{\Delta V}{g} \text{ (ALLIEVI) (1)}$$

$$\Delta H = \pm \frac{2L\Delta V}{gt} \text{ (MICHAUD) (2)}$$

PRESSURE AND ANGULAR DEVIATION AT THE JOINT

Water hammers

Where:

a : wave propagation speed (m/s)

ρ : water density (1,000 kg/m³)

ε : modulus of elasticity of the water (2.05.10⁹ N/m²)

E : modulus of elasticity of the material (ductile iron: 1.7.10¹¹ N/m²)

D : inner diameter (m)

e : pipe thickness (m)

ΔV : absolute value of the variation in changes in constant flow before and after the water hammer (m/s)

ΔH : absolute value of the variation in maximum pressure around the normal static pressure (m of water gauge)

L : length of the pipeline (m)

t : effective closing time (sec)

g : acceleration due to gravity (9.81 m/s²)

In practice, the wave propagation speed for water in ductile iron pipes is 1,200 m/s.

Formula (1) takes into account the rapid variation in flow velocity:

$$\left(t \leq \frac{2L}{a} \right).$$

Formula (2) takes into account the linear variation in the flow velocity as a function of time (function of a valve closure law, for example):

$$\left(t \geq \frac{2L}{a} \right).$$

The pressure varies from $\pm \Delta H$ around the normal static pressure. This figure is at its maximum for the instantaneous closure of a valve, for example.

These simplified formulae provide a maximum evaluation of the water hammer and must be used with caution. They assume that the pipe is not fitted with anti-surge devices and that head losses are negligible. Furthermore, they do not take into account such limiting factors as the pump turbine operation and the pressure of saturating vapor in a pressure drop.

Examples

Pipe DN 200, Class C40, length 1 000 m, discharge at 1.5 m/s:

$a = 1,200$ m/s

- Case 1: sudden shutdown of a pump (negligible head loss and no anti-surge protection):

$$\Delta H = \pm \frac{1\,200 \times 1.5}{9.81} = 183 \text{ m (i.e. approximately 18 bar)}$$

- Case 2: closure of a valve (effective time: 3 seconds):

$$\Delta H = \pm \frac{2 \times 1\,000 \times 1.5}{9.81 \times 3} = 102 \text{ m (i.e. approximately 10 bar)}$$

Complete evaluation

The BERGERON graph method can be used to determine precisely the pressures and flow rates as a function of time at any point in a pipe subject to a water hammer.

Computer programs are now available for resolving these complex problems.

PRESSURE AND ANGULAR DEVIATION AT THE JOINT

Water hammers

Prevention

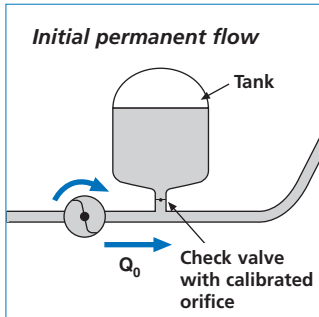

The protective systems that can be installed to limit water hammers to an acceptable level are varied and must be adapted to suit each situation.

They act by slowing the change in fluid velocity or by limiting the pressure surge in relation to the pressure drop.

The user must determine the pressure surge and pressure drop envelope created by the water hammer and judge, according to the pipe profile, the type of protection to be installed:

- Pump inertia impellor
- Pressure relief valve
- Air tank or self-regulating surge tank
- Auxiliary suction
- Balancing column

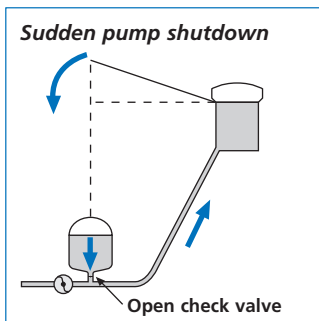

Surge tanks are frequently used. They have two functions:

- Limit the pressure surge (head loss controlled by a check valve)
- Prevent cavitation (tank drainage)

In the event of a sudden pump shutdown, the pressure drop is offset by a flow rate provided by draining the tank.

When the direction of water flow reverses, the energy in the water mass is transformed into a head loss by filling the tank through a calibrated check valve.

The pipeline profile plays a decisive role when deciding the tank dimensions. In practice, the minimum pressure drop curve (after installing protection devices) must not fall more than five meters below the actual profile of the main.

The surge tank volume can be determined from the PUECH and MEUNIER charts or using software.

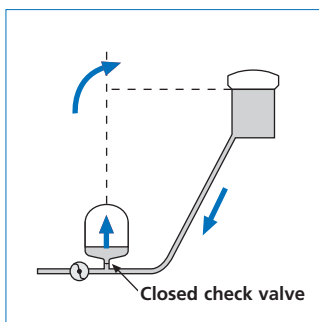

Note that ductile iron has a high safety margin:

- Surges:  permits a 20% excess over the allowable operating pressure for transient pressure surges. Refer to ALLOWABLE OPERATING PRESSURES on page 33.
- Pressure drops: the joint guarantees a seal against external ingress, even in case of a partial vacuum in the main.

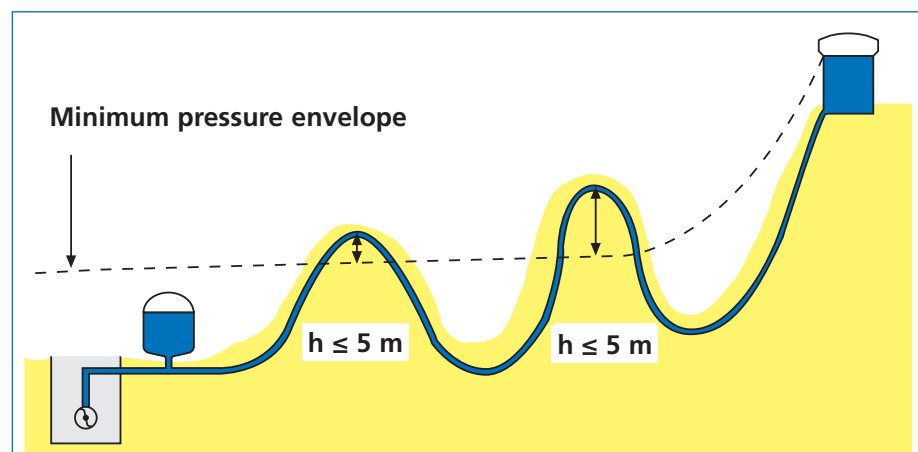

PRESSURE AND ANGULAR DEVIATION AT THE JOINT

Joint deflection

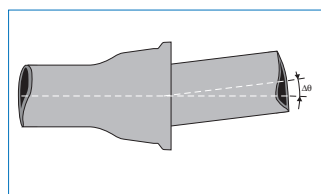

PAM socket joints allow for angular deflection. In addition to the obvious advantages during laying and to accommodate ground movement, angular deflection allows the incorporation of large radius bends without using fittings, as well as a certain amount of adjustments to the layout.

Angular deflection (expressed in degrees)

DN	Non-restrained junction	Restrained junction				
	STANDARD	STANDARD VI	STANDARD VE*	PAMLOCK	UNI VI	UNI VE
60	5	5				
80	5	5	5		3	3
100	5	5	5		3	3
125	5	5	5		3	3
150	5	5	5		3	3
200	5	4	4		3	3
250	5	4	4		3	3
300	5	3	4		3	3
350	4	3	3		3	3
400	4	2	3		3	3
450	4	2	3		3	3
500	4	2	3		2	3
600	4	2	3		2	2
700	4	2	2		2	2
800	4		2			2
900	4		1.5			1.5
1000	4		1.5			1.2
1100	4		1.5			
1200	4		1.5			1.1
1400	3			1		1.2
1500	3			1		0.9
1600	3			1		0.9
1800	2.5			0.8		
2000	2			0.8		

* only for fittings

Other joints:

– BLUTOP®, BLUTOP® Vi

DN / OD	Allowable deflection during installation
75	6°
90	6°
110	6°
125	6°
140	6°
160	6°

- STANDARD for ISOPAM pipeline

DN	Allowable deflection during installation θ	Pipe length m	Bend radius R m	Displacement Δd cm
	°			
100	4	6	86	42
125 and 150	3.5	6	98	37
200 and 250	3	6	115	32
300 and 350	2.5	6	138	26
400 and 500	2	6	172	21

Note: the restriction is caused by the dimensions of the thermal insulation.

PRESSURE AND ANGULAR DEVIATION AT THE JOINT

Joint deflection

Displacement and bend radius:



Some large radius bends can easily be created with successive deflections in socketed joints. In this case, pipes must be inserted while perfectly aligned, both horizontally and vertically. The joint must only be deflected when fully assembled.

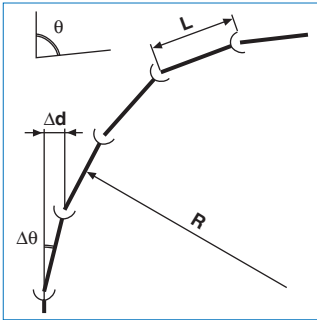

- Bend radius: $R = \frac{L}{2 \sin \frac{\Delta\theta}{2}}$

- Number of pipes required for a change in direction:

$$N = \frac{\theta}{\Delta\theta}$$

- Length of the change in direction: $C = N \times L$

Where:

Δd : pipe displacement (in m)

L : pipe length (in m)

θ : angle of the change in direction (in degrees)

$\Delta\theta$: joint deflection (in degrees)

C : length of the change in direction (in m)

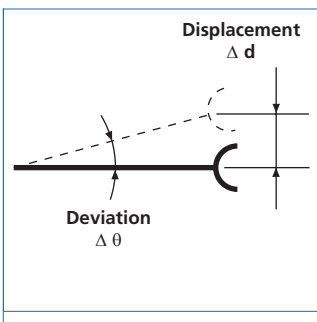

Angular deflection °	Pipe length					
	6 m		7 m		8 m	
	Bend radius m	Displacement cm	Bend radius m	Displacement cm	Bend radius m	Displacement cm
1	-	-	401	12	458	14
2	172	21	201	24	229	28
3	115	31	134	37	153	42
4	86	42	100	49	115	56
5	69	52	-	-	-	-
6	57	63	-	-	-	-

Bend radii vary according to the effective pipe length.

The length may be greater than 8 m for DN 1000 pipes and above.

SURROUNDING CONDITIONS OF THE PIPELINE

Soil (mechanical properties)

The values in the tables are those generally accepted for soil characterization. They can be used to calculate some of the simplified design formulae in this catalog and assess their scope of validity. They cannot replace actual site or laboratory measurements.

Average characteristics of commonly encountered soils

Type of ground	Dry/Wet		Submerged	
	Φ	γ	Φ	γ
	degrees	t/m ³	degrees	t/m ³
Fragmented rock	40°	2	35°	1.1
Gravel and sand	35°	1.9	30°	1.1
Gravel and sand Silt and clay	30°	2	25°	1.1
Silt and clay	25°	1.9	15°	1
Humus organic clay/silt	15°	1.8	no average characteristics	

Φ : Angle of internal friction (in degrees)

γ : Density (in t/m³)

Soil classification

Soil group	Description	Materials according to French standard NF P 11-300 in specific conditions (w, m or d) (2)
G1	Clean sand and gravel (D _{max} < 50 mm) Slightly silty sand and gravel	D1, D2, D3 DC1, DC2, DC3 (3) B1-B3 C1B1, C1B3, C2B1, C2B3
G2	Slightly clayey sand and gravel	B2-B4 C1B1, C2B2, C1B4, C2B4
G3	Very silty sand and gravel, silt with low plasticity, fine sand with low contamination (IP < 12)	A1 B5 C1A1, C2A1, C1B5
G4	Clayey to very clayey sand and gravel, clayey fine sand, clayey silt and marl with low plasticity (IP < 25)	A2 B6 C1A2, C2A2 C1B6, C2B6
G5	Clay and marly clay, silt with high plasticity (IP < 25)	A3, C1A3, C2A3 A4, C1A4, C2A4

(2) w: "wet"; m: "moderate"; d: "dry" according to NF P 11-300

(3) Backfill created according to the SETRA guide on backfilling trenches, published in May 1994.

Refer to page 66 for the characteristics provided by French regulations "Fascicule 70".

SURROUNDING CONDITIONS OF THE PIPELINE

Unstable ground

Elastomer joint gaskets provide ductile iron pipelines with a degree of flexibility, which ensures an element of safety when passing through inconsistent or unstable ground.

A pipeline's route may pass through inconsistent or unstable ground (marshy regions, subsidence due to pumping underground water, mining areas, consolidation of roadwork backfill, etc.).

In each of these cases, it is necessary to assess the potential subsidence and take all precautions to minimize the effect of soil movement on the pipeline. Site measurements are always recommended.

Experience has shown that when soil movement occurs, pipes must be able to match the deformation imposed by the mass of moving earth rather than resisting the often considerable mechanical stress (axial and bending stresses). In this respect, PAM socket joints are nil tension and nil bending points, within the range of their joint deflection.



For extensive and uniform subsidence, the joint allows the pipe to function like a flexible chain. Deformation extremes are obviously determined by the maximum admissible deflection and slippage for each joint.

Admissible subsidence provided by joint deflection

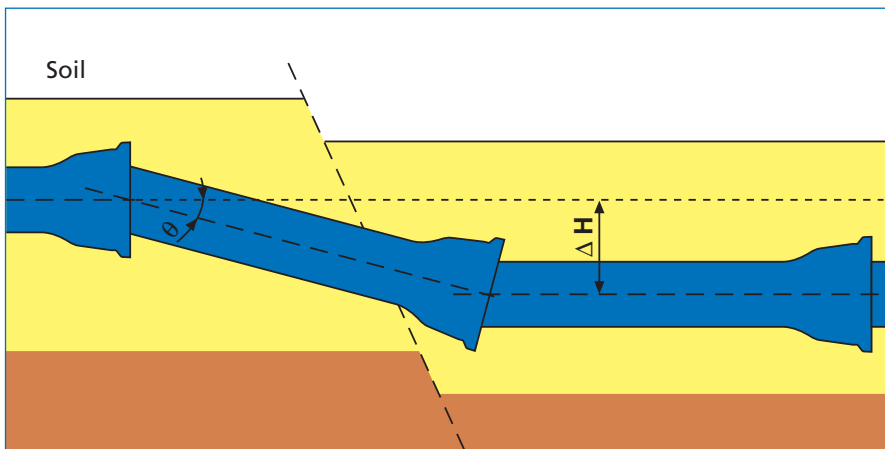

Subsidence: $\Delta H = l \operatorname{tg} \theta$

Axial slip: $\Delta l = (\Delta H^2 + l^2)^{1/2} - l$

l : pipe length (m)

θ : admissible joint deflection

SURROUNDING CONDITIONS OF THE PIPELINE

Unstable ground

▣ Examples

For $\Delta H = 0.30$ m in DN 200

$\theta = 3^\circ$ (5° admissible)

$\Delta l = 7$ mm (20 mm admissible with the STANDARD joint)

There is no risk of the joint separating, since the slip can be entirely absorbed by the joint.

Chain behavior

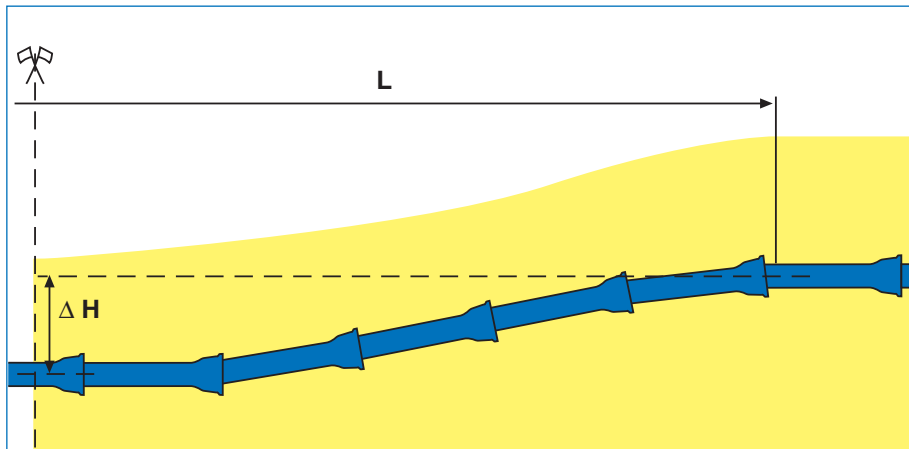

$$\text{Subsidence } \Delta H = 2l \left(\text{tg}\theta + \text{tg}2\theta + \text{tg}3\theta + \dots + \text{tg} \frac{n}{4} \theta \right)$$

$$\text{Axial extension: } \Delta L \approx \left(L^2 + \frac{16}{3} \Delta H^2 \right)^{1/2} - L \text{ (where } \theta \text{ is very small)}$$

l = pipe length

L = length of the subsided section

n = number of pipes in the subsided section $\left(n = \frac{L}{l} \right)$



The pipe moves with the soil until the extreme limit before separation of the joint, according to the admissible play in the joints.

Note: in the event of subsidence causing high ΔL extension, one solution may be to anchor the joints and offset the extension with collars installed at the borders between the stable and unstable areas.

▣ Examples

In DN 300, for $\Delta H = 0.5$ m and $L = 300$ m:

$\theta_{av.} = 0.04^\circ$ (5° admissible)

$\Delta L = 3$ mm

A single joint can support the extension due to the curvature adopted by the 300 m section that has subsided 0.5 m below its original center.

SURROUNDING CONDITIONS OF THE PIPELINE

Earthworks*

Trench excavation and backfilling depend on the following parameters:

- Environment
- Characteristics of the main (type of joint and diameter)
- Type of soil (presence or absence of water)
- Laying depth

The laying recommendations given below are those usually prescribed for ductile iron pipes.

Preparatory work

After conducting a thorough survey of the environment and obtaining authorization from the various utilities (telecoms, gas, water, etc.), the contractor marks out the route and profile of the main to be laid, in accordance with the project specifications, and ensures that actual conditions match the assumptions defined in the project brief.

Trench opening

Prepare to break up road surfaces by pre-cutting the edges of the trench to avoid damaging the neighboring areas. The width is slightly greater than the trench.

Excavation is usually carried out with a mechanical digger, suited to the pipe diameter, the type of ground and installation depth.

Trench width

The trench width depends on the DN, the type of soil, the installation depth and the methods of shoring and compaction.

Care is taken during work to:

- Stabilize the walls, either by battering or shoring
- Clear lumps of rock or clods of earth from the edges of the excavation to prevent them from falling
- Deposit the excavated material so as to leave a 0.4-meter space between the pipe and the trench

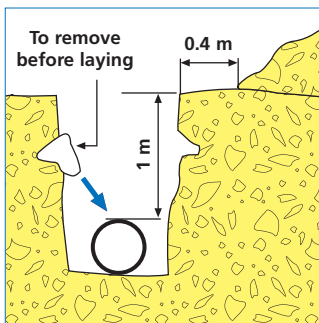

Trench depth

Section 47 of French regulations "Fascicule 71" specifies that: "Trenches are prepared at every point to the depth indicated by the longitudinal profile. Unless otherwise specified, the normal trench depth is such that the depth of backfill above the crown of the pipe is not less than 1 meter." This depth is justified by the need to protect against frost damage.

(*) According to the published specifications for water pipe foundations, "LAYING PIPELINES".

SURROUNDING CONDITIONS OF THE PIPELINE

Earthworks

Types of soil

Soils can be divided into three main classes, based on their cohesion:

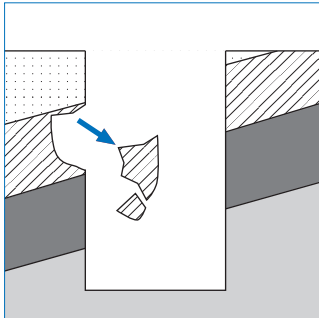

Rock

Extremely cohesive, making excavation difficult but not precluding any possibility of collapse.

Cracks are sometimes present, which can result in complete chunks falling.

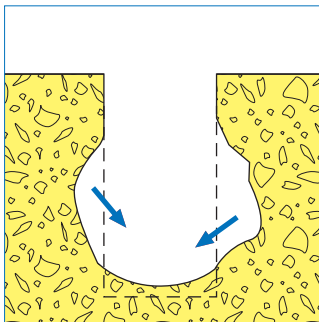

Friable soil

By far the most common. These exhibit a certain amount of cohesion, which allows them to hold together for a while during excavation. Cohesion can change very rapidly under the influence of the factors already mentioned (water ingress, nearby equipment movement, etc.): landslides are possible.

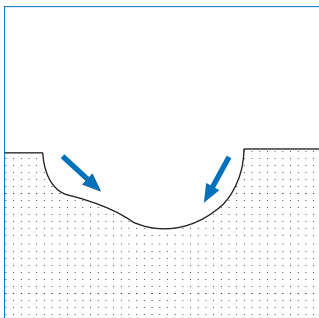

Non-cohesive ground

This ground lacks any cohesion, such as dry sand, mud or freshly deposited back-fill. This type of ground collapses almost instantly. Special procedures are needed when working with this type of ground.

Protection against the danger of collapse is therefore essential:

- Either by sloping the trench sides backwards
- Or by shoring the trench sides

The precautions to be taken also depend on the situation (urban or rural), and the depth of installation.

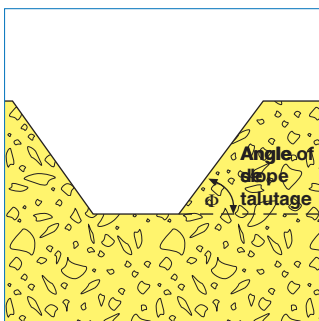

Battering

Battering is rarely used in urban situations because of the space needed and involves giving the walls an outward slope known as “the angle of slope”, which must be close to the internal friction angle of the soil. This angle varies with the type of soil.

Refer to SOILS (MECHANICAL PROPERTIES) on page 54.

SURROUNDING CONDITIONS OF THE PIPELINE

Earthworks

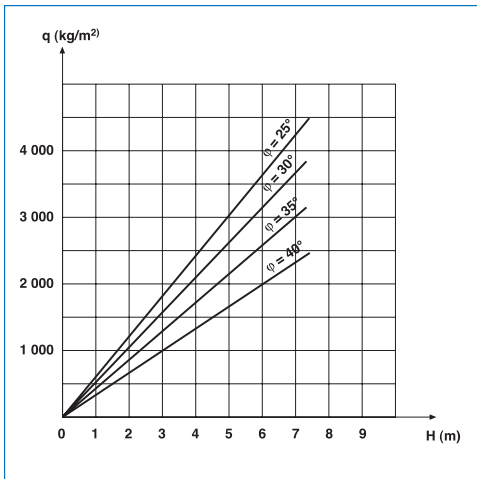

Trench shoring

There are numerous shoring techniques, meaning that it is important to analyze and adapt them before starting work.

Shoring must be used in the cases prescribed in existing regulations or generally when required by the type of ground.

The most common shoring techniques:

- Prefabricated timber panels (joined or single)
- Timber or metal sheeting
- Pile-driven sheets

Whichever technique is used, the earth pressure must be taken into consideration. Panels must be capable of resisting a thrust exerted over their whole height, given by the formula:

$$q = 0.75 \gamma H \operatorname{tg}^2 \left(\frac{\pi}{4} - \frac{\varphi}{2} \right)$$

γ : soil density (in kg/m³) (approximately equal to 2,000 kg/m³)

φ : angle of internal soil friction (in radians)

q : thrust (in kg/m²)

H : depth (in m)

Trench bottom

The trench bottom must be levelled to comply with the longitudinal profile of the main, and all stony protrusions or rubble must be eliminated. Ensure that the pipe rests on evenly distributed soil.

Joint holes need to be excavated to facilitate assembly.

Presence of water: excavation must be from downstream to upstream in order to allow the water to drain by itself from the trench bottom.

If the trench passes through waterlogged ground (water table), the water may need to be removed from the trench by:

- Pumping it out (directly from the trench or a sump at the side)
- Dewatering with probes or filter wells

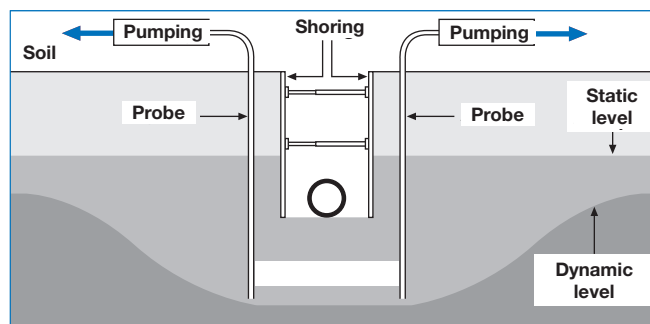
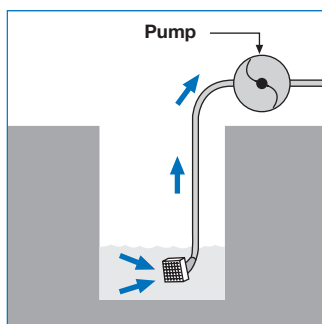

SURROUNDING CONDITIONS OF THE PIPELINE

Earthworks

Pipe bed, pipe surround and backfill

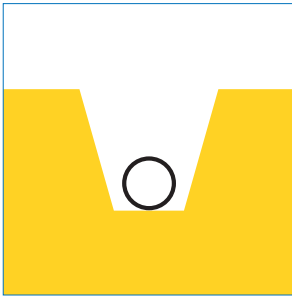

□ Pipe bed

The trench bottom provides the pipe foundation. In cases where the native soil is well broken up and relatively homogeneous, the pipes can be laid on the trench bottom, as previously described.

It is essential to ensure that the pipes are properly bedded on the soil, particularly in case of large diameters. If the trench bottom is not suitable for direct laying, a bed of pea gravel or sand must be laid over an approximate thickness of 10 cm.

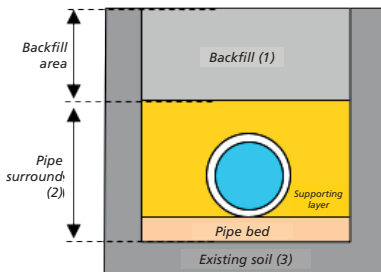

Refer to HEIGHTS OF COVER on page 63 for details of the different types of surrounds and backfills, in terms of:

- Environment (earth loading, traffic, backfill quality)
- Pipe diameter
- Types of soil encountered

□ Particle size

The following limit values apply to the pipe surround area, up to 15 cm above the pipe's assembly crown.

Type of coating	Natural granular and limestone backfill	Crushed backfill other than limestone (4)	Reuse of the excavated materials (Dmax)
Biozialium + Aquacoat	0-31.5 ⁽¹⁾	0-16	63 mm (92% < 32 mm)
Zinc + synthetic paint	Particle size 63 mm less than 2%	Particle size 32 mm less than 2%	
TT PE (extruded polyethylene)	0-6.3 ⁽³⁾	0-4	12 mm (92% < 6 mm)
TT PUX (polyurethane + epoxy ends)	Particle size 12 mm less than 2%	Particle size 8 mm less than 2%	
ZMU (fiber-reinforced mortar)	0-63	0-63	100 mm (92% < 63 mm)
PE sleeve	0-2 ⁽²⁾	0-2	2 mm
	Sand	Sand	Sandy materials

(1) Granular materials with low or medium hardness and angularity (rounded stones and gravel) and crushed limestone with a particle size of 0/31.5

(2) Coarse sand, particle size 0-2 mm

(3) Fine gravel (similar to the consistency of rice) with over 50% elements with $D > 2$ mm – Particle sizes: 0/4 – 2/4 – 0/6.3 – 2/6.3 – 4/6.3

(4) Crushed materials with high hardness and angularity: natural materials (gravel, stones and flint), artificial materials (slag) and recycled materials (deconstruction materials)

Note: the different coatings do not apply to the entire range of DN sizes.

□ Pipe surround

Two types can be distinguished:

- A pipe supporting surround (to resist any ovalization in the case of large diameter pipes), consisting of soil free from stones, and so on, or backfill compacted on the sides.
- A protective surround (in the case of highly heterogeneous soil) consisting of stone-free soil or sand; this surround can act as both protection and support.

□ Main backfill

This is usually the non-compacted excavated earth (away from the road) or compacted backfill (beneath the road) when required by the project specifications.

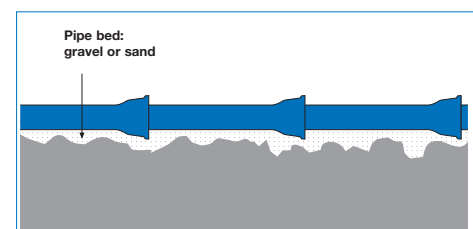

SURROUNDING CONDITIONS OF THE PIPELINE

Soil aggressivity

Buried pipes are subject to a variety of stresses, including soil and backfill corrosivity.

*The coatings on the basic versions of the **PAM** range of pipes boast a high level of corrosion resistance (400 g/m² Zn85 Al15 alloy optionally enhanced with copper, or zinc 200 g/m²), which is suitable for most applications.*

*However, the soil's corrosivity must be assessed to determine whether additional protection is required, such as a polyethylene sleeve or special coatings. **PAM**'s technical staff can carry out a soil survey at the customer's request.*

Topographical study

General corrosion indicators

The general corrosion indicators are determined with the aid of a detailed map (Ordnance Survey type), which indicates:

- The ground contours: high spots are drier and better aerated, therefore less corrosive, while low spots are wet and unaerated, therefore likely to be more corrosive
- Water courses to be crossed, wet areas
- Ponds, marshes, lakes, peat beds and other low areas, rich in humic acids and bacteria, and often polluted
- Estuaries, polders, salt marshes and saline soils bordering the sea

Pollution and specific corrosion indicators

Drawings and plans (obtained from public record offices) can be used to determine the following:

- Areas polluted by various types of effluent, such as liquid manure and distillery, dairy and papermaking waste, or by sewage, mainly from households
- Industrial waste, like slag and clinker
- The proximity of other mains, like leaking sewage mains
- Industrial plants or equipment using direct current electricity (cathodic protection, electric traction systems, plants, etc.)

This survey indicates the various strata traversed and provides information on the nature of the terrain and its natural corrosivity.

SURROUNDING CONDITIONS OF THE PIPELINE

Soil aggressivity

Geological survey

An initial soil investigation can reveal the following types of ground:

- Low risk:
 - Sand and gravel
 - Stony material
 - Limestone
- High risk:
 - Marl
 - Clay
- Very high risk:
 - Gypsum
 - Pyrites (iron pyrites, chalcopyrite, copper pyrites, etc.)
 - Salts used in the chemical industry (sodium chloride and calcium sulfate)
 - Fossil fuels (lignites, peat, coal and bitumen)

Note any indications of the presence of fossil fuels, especially pyrite ammonites, which reveal indicate that the soil contains pyrites (iron sulfides) and is therefore very corrosive, particularly since it is anaerobic.

Hydrogeology

Moisture is a contributing factor in soil corrosivity.

A hydrogeological study identifies impermeable soils likely to retain water, as well as the presence of water-retaining areas.

The boundaries of these soils are often marked by the presence of springs.

These boundaries warrant particular attention, since the corrosivity of the impermeable layer may be very high. The same applies to water-retaining areas if they drain neighboring soils containing soluble mineral salts (sodium chloride, calcium sulfate, etc.).

Site surveys

Through visual observations, measurements (resistivity) and analyses (soil samples), site surveys help to confirm and complement the topographical and geological findings.

The resistivity of a soil provides information about its ability to promote the phenomenon of electrochemical corrosion of a metal. It is an especially significant parameter, because:

- It integrates virtually all the factors that influence corrosivity (presence of salts, water, etc.).
- It is very easy to measure on site (the Wenner four-pin method).

The different measurement points are plotted along the provisional route for the pipeline. Their intervals are dictated by the topography of the terrain and the values obtained.

The lower the resistivity, the greater the soil corrosivity. In case of a resistivity value below 3,000 Ω -cm, the measurements should be confirmed by taking a sample at the depth of installation and measuring its resistivity (gross and minimum values) in a laboratory.

For any inquiries, contact PAM.

SURROUNDING CONDITIONS OF THE PIPELINE

Heights of cover

The minimum and maximum heights of cover depend on the pipe characteristics and laying conditions.

Definitions

In French regulations "Fascicule 70", a distinction is made between:

- **The backfill area (1)**
- **The pipe surround (2):**
 - The pipe bed and pipe surround backfill up to at least 0.10 m above the assembly crown for flexible pipes
 - The pipe bed and surround up to the horizontal diameter for rigid pipes
- **The existing soil (3)**

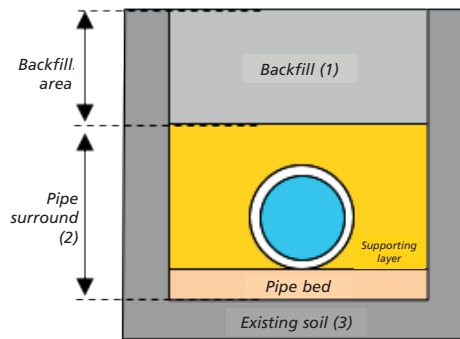

The **pipe surround (2)** protects and/or provides stability for the pipeline.

It must be executed in accordance with varying requirements depending on the:

- Pipe characteristics (rigid, semi-rigid or flexible)
- External load (height of cover, traffic, etc.)
- Invariably rocky or heterogeneous nature of the ground

The **backfill area (1)** varies according to the area involved (rural, semi-urban or urban) and must take road stability into account.

Other constraints also affect laying conditions:

- Keeping the pipe frost-free (minimum heights of cover)
- Passing through critical safety areas (railways, motorways, etc.), which require special arrangements
- Current regulations and local requirements applicable to roadways

Height of cover diagrams

The following diagrams show the maximum and minimum heights of cover for ductile iron pipes (Classes C40, C30 and C25) with or without traffic.

Four types of laying techniques corresponding to current best practices are represented. In all other cases, contact  or refer to French regulations "Fascicule 70".

They are based on the following assumptions:

- Pipe resistance and deformation criteria according to EN 545
- Calculation model pursuant to French regulations "Fascicule 70"

SURROUNDING CONDITIONS OF THE PIPELINE

Heights of cover

Four laying techniques

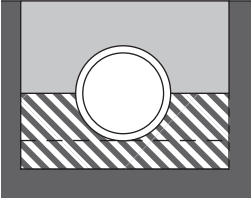
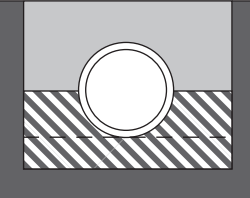
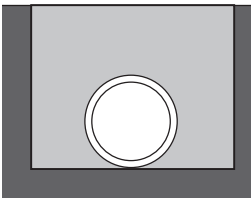
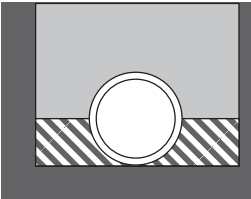
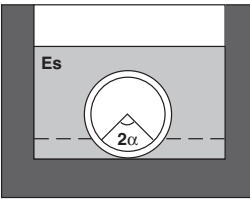
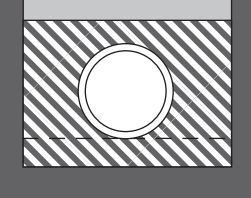
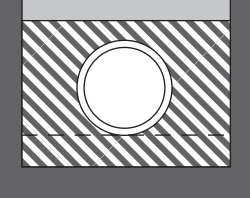
	Case 1	Case 2	Case 3	Case 4
			DN ≤ 1400	DN ≤ 600
	DN ≤ 600	DN 60 to 2000		
			DN > 1400	DN > 600
				
Pipe bed	Levelled base	Levelled base	Bed made from selected and appropriate materials	Bed made from selected and appropriate materials
Backfill area (2) – Soil group * – Compacting	G3 Non-compacted	G3 Controlled compaction q5 t2	G2 Compaction q5 t1	G1 Compaction q4 t1
– Es (MPa) – 2 α (°)	0.5 60	1 90	1.2 90	2 90
Choice of materials	The backfill materials used (selected or otherwise) that are directly in contact with the pipe must be free of stones or corrosive elements.			

* See table 1.

The cases defined above exclude aquifers and reinforced trenches.

For all other cases (beneath barriers, reinforcements, etc.), refer to French regulations "Fascicule 70" or contact 

SURROUNDING CONDITIONS OF THE PIPELINE

Heights of cover

Maximum and minimum heights of cover

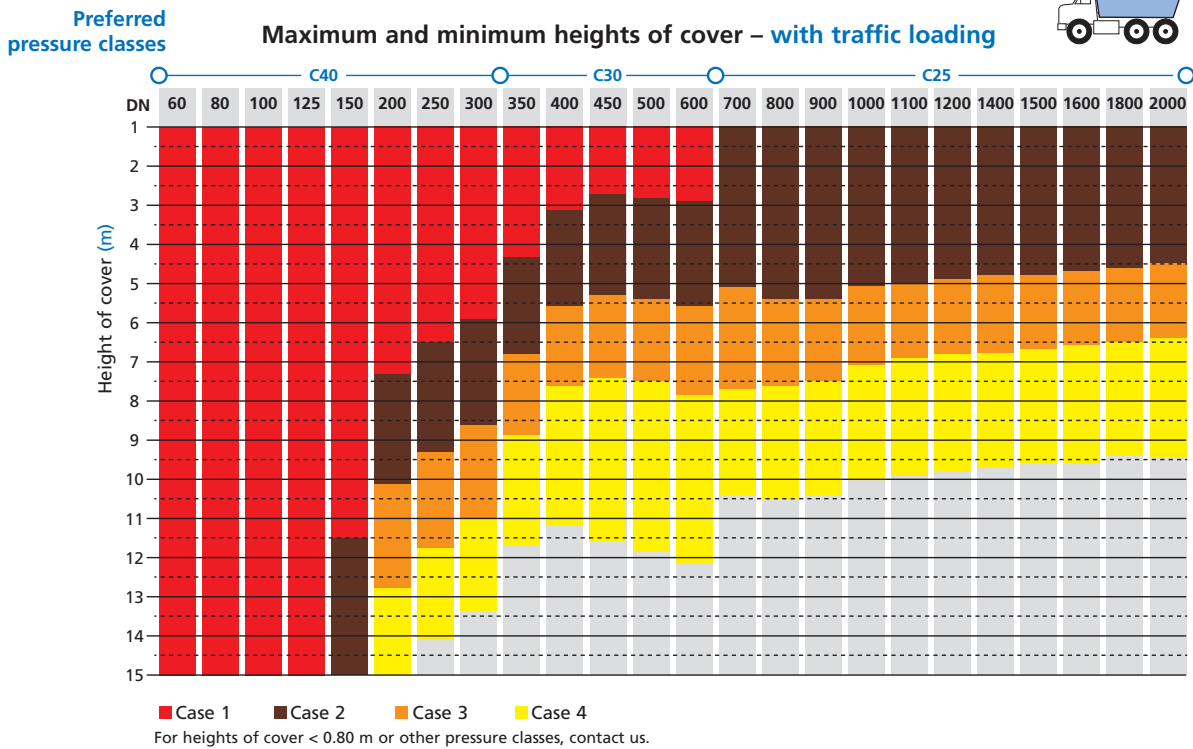
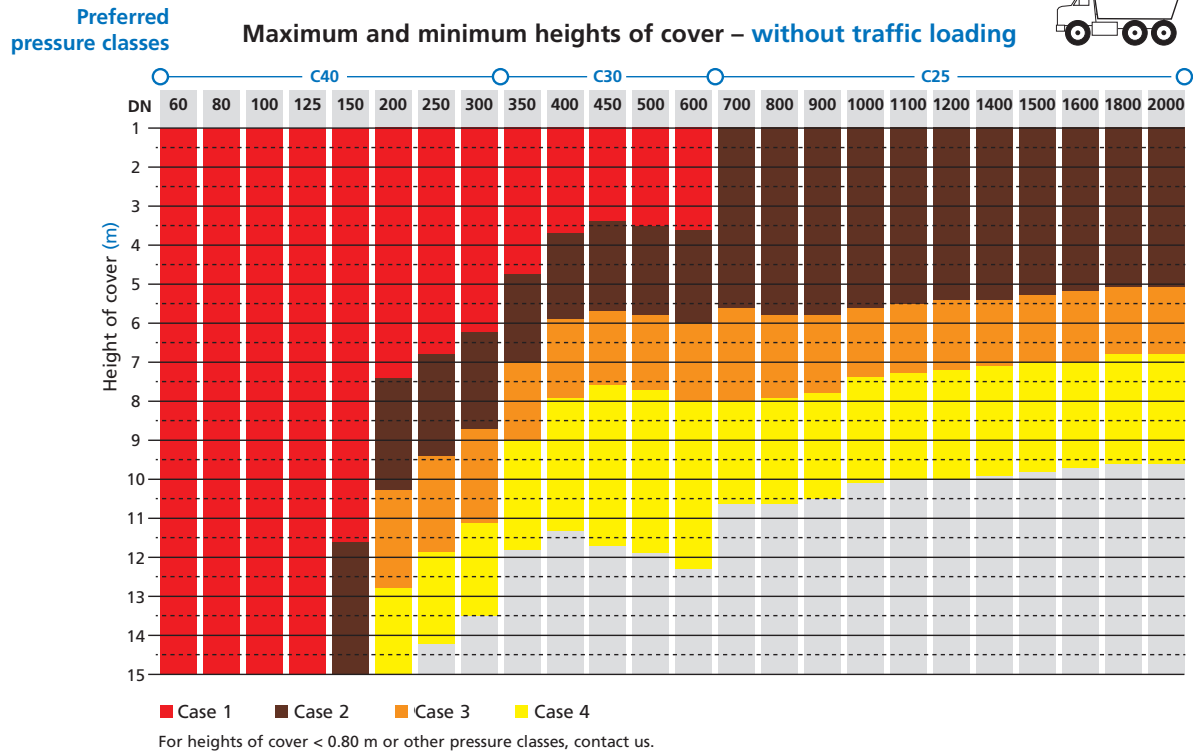

SURROUNDING CONDITIONS OF THE PIPELINE

Heights of cover

Elements from French regulations “Fascicule 70”

The calculation method used takes into account:

- Five soil groups
- Three levels of compaction quality and, if applicable, the influence of:
 - The aquifer on soil parameters
 - Conditions for removing sheeting according to the trench width
 - Traffic loading (two 30-ton triple-axle trucks crossing)

Soil group	Installation level		
	Recommended densification targets		
	$q_5-t_2^{(1)}$	$q_5-t_1^{(1)}$	$q_4-t_1^{(1)}$
		Minimum average value ⁽³⁾ : 90% of the SPO ⁽²⁾	Minimum average value ⁽³⁾ : 90% of the SPO ⁽²⁾
G1	2	5	10
G2	1.2	3	7
G3	1	2.5	4.5
G4	0.6	1.5	3
G5	-	-	2

(1) In accordance with French standard NF P 98-331:

- q_4 at least 95% of the SPO on average
at least 92% of the SPO at the bottom layer
- q_5 at least 90% of the SPO on average
at least 87% of the SPO at the bottom layer

(2) Standard Proctor Optimum

(3) Across the height of the layer

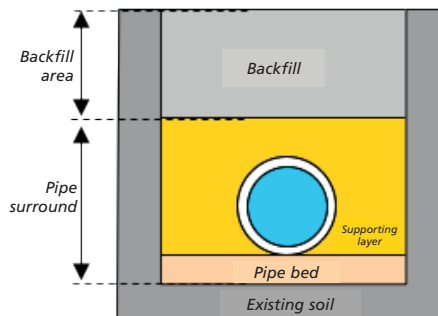

Other methods of calculation

Other calculation methods can be used:

- Annex F (informative) of European standard EN 545 – Ductile iron pipes, fittings, accessories and their joints for water pipelines – Requirements and test methods – Calculation method of buried pipelines, heights of cover
- US Standard ANSI/AWWA C 150/A 21.50 – Thickness design of ductile iron pipe
- ISO 10803 “Design method for ductile iron pipes”
- ATV 127
- DIPRA

SURROUNDING CONDITIONS OF THE PIPELINE

Soil loads (pipe performance)

The various types of pipe can be divided into three categories according to how they react to external loads:

- Rigid pipes
- Flexible pipes
- Semi-rigid pipes

Ductile iron pipes are classed as semi-rigid. They offer a good compromise between resistance to top loading and vertical deflection, thereby providing long-term operational safety.

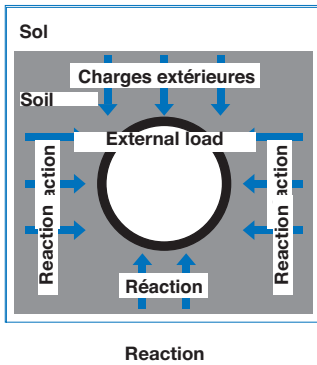

Pipe/soil system

The only way to understand the mechanical performance of a buried pipe is to consider the pipe/soil system: the interaction of the pipes with the surrounding soil depends on their stiffness or flexibility, which causes different installation constraints.

Pipes can be divided into three categories according to their resistance to external loads:

- Rigid pipes
- Flexible pipes
- Semi-rigid pipes

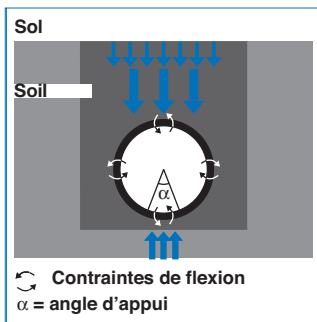

Bending stresses
 α = bedding angle

Rigid pipes

Example

Prestressed concrete.

Performance

Rigid pipes only tolerate a very small amount of ovality before they fail. The deformation is insufficient to leverage the side support resistance of the backfill. The entire soil top load is supported by the pipe, which exerts high bending stresses on the walls.

Design criteria

Usually the maximum crushing load.

Consequences

Rigid pipes favor concentrated loads at the pipe crown and invert. The performance of the rigid pipe/soil system is highly dependent on the bedding angle α and therefore on good bed preparation, particularly if there is any traffic loading.

SURROUNDING CONDITIONS OF THE PIPELINE

Soil loads (pipe performance)

Flexible pipes

Example

Plastic, steel, etc.

Performance

Flexible pipes can withstand high vertical deflection without failure. The soil top load is therefore simply balanced by the pipe side support provided by the surrounding backfill.

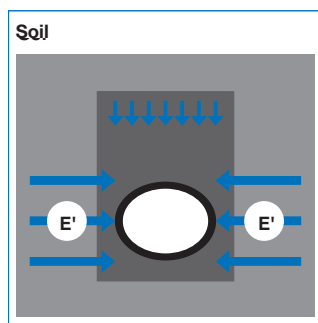

Design criteria

Maximum allowable ovalization or maximum allowable bending stress, as well as resistance to buckling.

Consequences

The stability of the flexible pipe/soil system is directly dependent on the capacity of the backfill to develop passive side support resistance, therefore on its modulus of passive soil resistance E' and consequently on the quality of the backfill and its compaction.

Semi-rigid pipes

Example

Ductile iron.

Performance



Semi-rigid pipes sustain sufficient ovality for part of the soil top load to mobilize side support from the backfill. The forces brought into play are therefore passive sidefill support and internal bending stresses in the pipe wall. The resistance to top loading is therefore distributed between the resistance of the pipe itself and that of the soil surround, the contributions of each being a function of the ratio of pipe and soil stiffness.

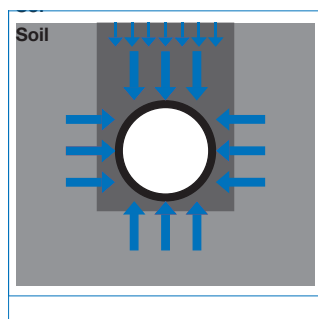

Design criteria

Maximum allowable bending stress (for small diameters) or maximum allowable ovalization (for large diameters).

Consequences

By distributing the forces between the pipe and backfill, the semi-rigid pipe/soil system provides security against any changes in mechanical stresses over time or in the support conditions.

STANDARDS AND QUALITY

Product standards and related standards

PAM ductile iron pipeline products comply with the requirements of French (NF), European (EN) and international (ISO) standards.

PAM pipeline systems comply with applicable standards:

- French (NF) and European (EN) standards
- International (ISO or EN ISO) standards

Compliance with European or international standards reflects the high degree of quality of the ductile iron pipeline systems.

Specifications	Standards	
	European EN standards	International ISO standards
Technical specifications for ductile iron pipes	EN 545	ISO 2531
Socketed pipes	EN 545	ISO 2531
Socketed fittings	EN 545	ISO 2531
Flanged pipes	EN 545	ISO 2531
Flanged fittings	EN 545	ISO 2531
Ductile iron pipes, fittings, accessories and their joints compatible with plastic (PVC or PE) piping systems, for water applications and for plastic pipeline connections, repair and replacement		ISO 16631:2016
Junction type tests	EN 545	ISO 2531
Restrained junction type tests	EN 545	ISO 2531 ISO 10804-1
Cement mortar internal lining	EN 545	ISO 4179
External zinc-based or BIOZINALIUM coatings for pipes	EN 545	ISO 8179
PE external coating	EN 14628-1	-
Polyurethane external coating	EN 15189	-
ZMU external coating	EN 15542	-
Polyurethane internal lining	EN 15655-1	-
Heavy-duty epoxy coating of fittings	EN 14901-1	-
Pre-insulated pipes	-	ISO 9394
Polyethylene sleeve	EN 545	ISO 8180
Design methods for pipelines*	EN 545	ISO 10803
Site testing	EN 805	ISO 10802
Water supply Requirements for networks outside buildings	EN 805	-
Joint rings – Material requirements	EN 681-1	ISO 4633
Flange dimensions	EN 1092-2	ISO 7005-2
Ductile iron fittings for PVC-U or PE piping systems	EN 12842	-
Quality management systems – Requirements	ISO 9001	ISO 9001
Environmental management systems – Requirements	ISO 14001	ISO 14001
Energy management systems	EN ISO 50001	ISO 50001

* "Fascicule 70" regulations in France

STANDARDS AND QUALITY

Materials in contact with water intended for human consumption

Materials in contact with water intended for human consumption should not unacceptably affect water quality.

Regulatory and normative background

The characteristics of water intended for human consumption are defined in a European Directive. Refer to WATER INTENDED FOR HUMAN CONSUMPTION on page 6.

There is no European Directive or standard that defines technical requirements for materials in contact with water intended for human consumption used in production, treatment and distribution facilities, and which are aimed at verifying their compatibility with this type of water.

However, there is a French Regulation addressing this topic: the Regulation of 29 May 1997, as amended by the Regulation of 24 June 1998, and by the Regulation of 13 January 2000 and Regulation of 22 August 2002. Section 2 of this Regulation (Materials used for pipes and fittings, tanks and accessories) authorizes the use of materials whose composition meets the recommendations set down in the annexes (type and maximum content of components), and makes provisions, as applicable, for prior testing to assess the potential effect on the organoleptic, physical, chemical and biological quality of the water that comes into contact with the relevant materials.

Materials used by in contact with water intended for human consumption

The materials covered by these regulatory requirements are listed in the following table:

Material	Use
Cement mortar	Pipe lining
Black synthetic paint	Lining around pipe joints and certain fittings
Blue epoxy paint	Lining for certain fittings
Polyurethane epoxy varnish applied by cataphoresis	Lining for certain fittings
Epoxy powder	Special lining for certain fittings
Elastomers	Seal rings for pipes and fittings
Lubricant paste	Joint assembly
Aquacoat paint	Lining for NATURAL® pipes
Ductan	Lining for BLUTOP® pipes

Compliance

All the above-mentioned materials used by  in its products are covered by reports from organizations approved by the French health authorities under the French Regulation of 29 May 1997, certifying compliance with applicable regulations defined in this Regulation. All the materials listed are totally compatible with the distribution of water intended for human consumption.

These reports, as well as the technical documentation for the relevant products (pipes and fittings for distribution networks DN 60 to 2000 for water intended for human consumption), have been reviewed by an independent organization.

SUSTAINABLE DEVELOPMENT

Transport and laying

Transport

PAM uses modes of transport that emit low levels of CO₂ in order to supply its factories with raw materials and deliver its products to its customers.

Both **PAM**'s production and distribution sites are generally interconnected by rail and waterways.

In France for instance, the site in the Lorraine region at Pont-à-Mousson receives most of its raw materials via rail or waterway. The products manufactured are then loaded onto trains or barges, and then switched to a vessel at a port if necessary.

65% of manufactured products are transported by waterway, rail and sea

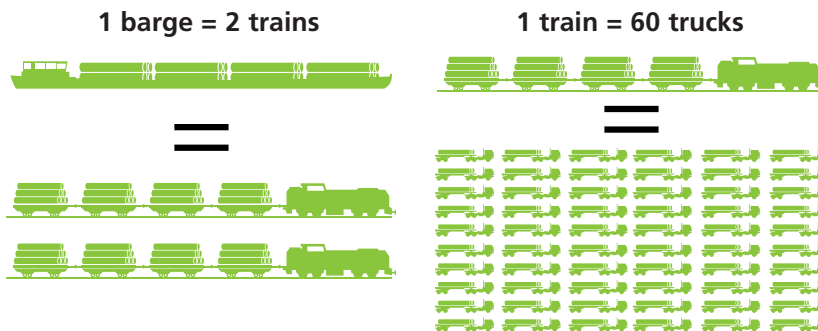

Installation

Offering superior resistance, solidity and flexibility, the **PAM** range of ductile iron pipelines allows the excavated earth to be reused as backfill for the trenches.

Simple, cost-effective and environmentally-friendly installation!

Laying pipelines may require the excavation of large amounts of earth, which may be as much as 5 to 10 times the volume of the pipeline laid. All too often, this earth is dumped and replaced with imported backfill.

The sturdy and solid nature of ductile iron pipelines, together with their resistance to cracking and the active properties of the coatings, allow for the use of native soil in most cases (following the clearing of larger stones) as a covering for the pipe bed.

● **PAM ÉCOPOSE – the cost-effective solution!**

Using “native” soil for the backfill reduces dependence on sand quarries and eliminates unnecessary road transport.

● **PAM ÉCOPOSE – the eco-friendly solution!**

In addition to reining in CO₂ emissions, PAM ÉCOPOSE minimizes pollution for local inhabitants and protects the land's natural resources.

SUSTAINABLE DEVELOPMENT

Life cycle assessment

100% of ductile iron materials can be recycled over and over again without any loss of performance.

Taking account of all operations, from production and installation through to the entire life cycle of the facility, is essential to ensure the correct approach to sustainable development.

PAM has carried out a life cycle assessment for its products in accordance with ISO 14040 and 14044, meaning that we can evaluate the environmental impact of our products on the human water cycle and identify opportunities for improvement and best-fit solutions.

The life cycle assessment can also be used to provide our customers with environmental product declarations in accordance with EN 15804 and ISO 21930 and help them assess their projects.

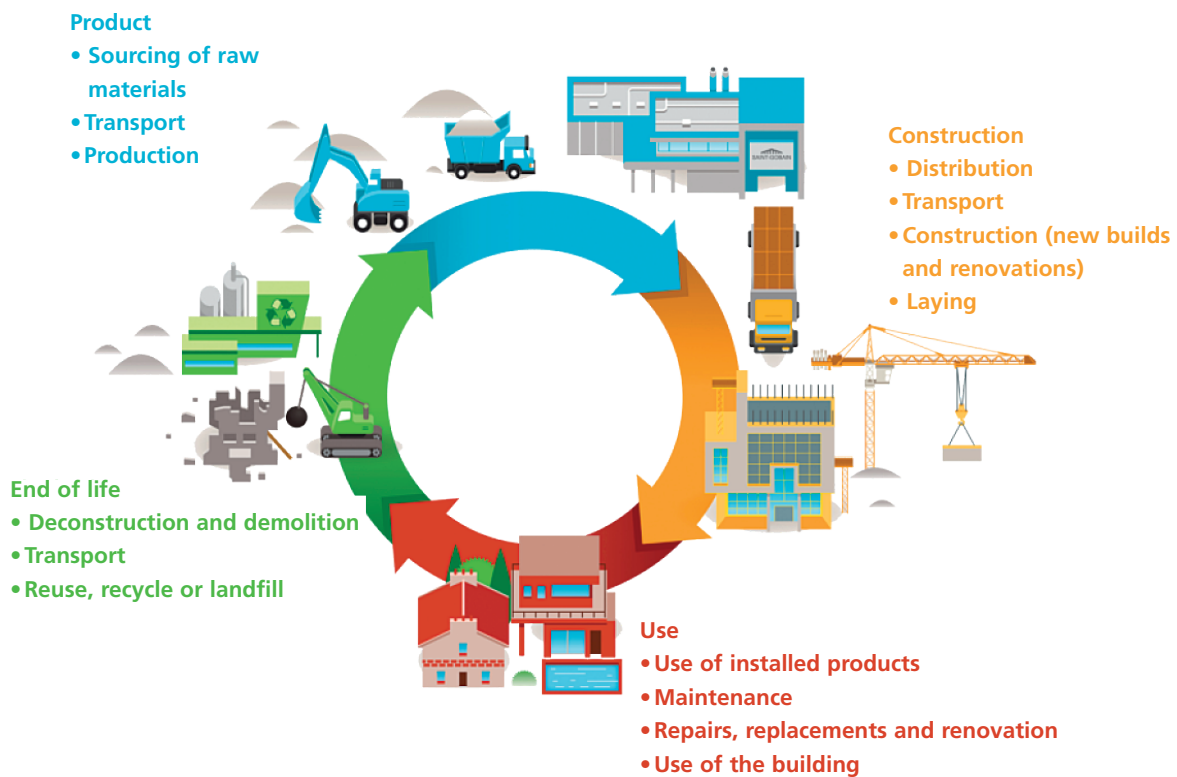

The environmental impacts of this product have been assessed throughout its life cycle. Its Environmental & Health Product Declaration has been verified by an independent third party.

SUSTAINABLE DEVELOPMENT

Total cost of ownership

Since sustainable development involves identifying the solution that offers the highest environmental performance combined with the best value for money, **PAM** SANT-GOBAN has pioneered and endorsed a tool for quantifying the life cycle cost of a pipeline.

Right from the drawing board stage of any project, **PAM** SANT-GOBAN provides stakeholders and interested parties with best-in-class solutions aimed at improving the performance of the networks to be laid and facilitating their installation, while streamlining costs throughout the life cycle.



Total cost of ownership

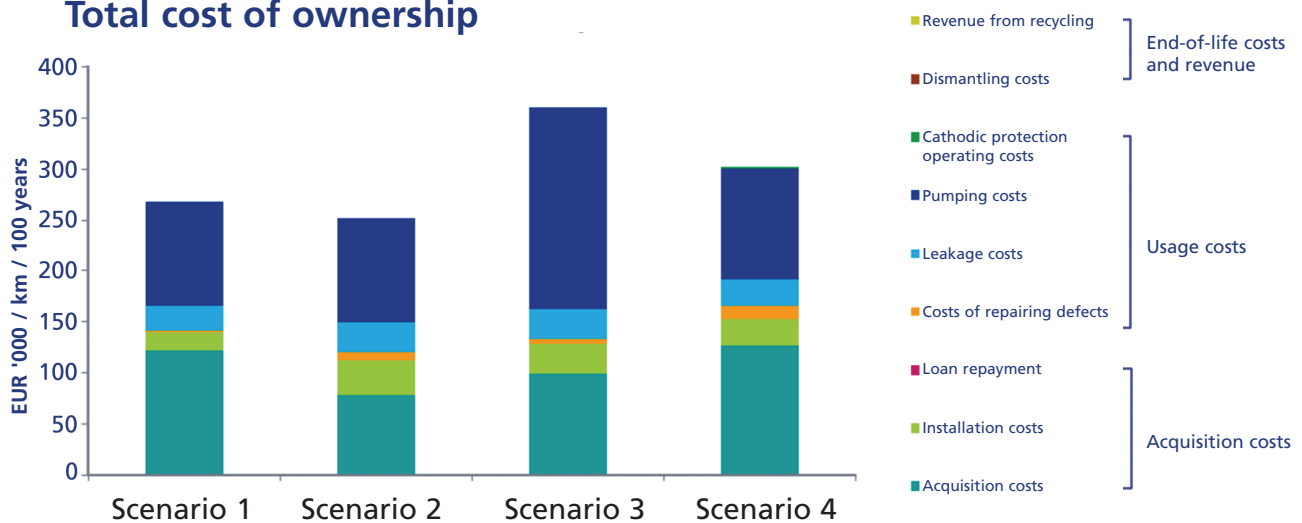

SUSTAINABLE DEVELOPMENT

Total cost of ownership

Investing money today in high-quality pipelines will reduce your organization's expenditure in the future.

The price of pumping water and the cost of water losses throughout the system's service life significantly outweigh the initial purchase cost.

The PAM TCO calculator is designed to assess the total cost of ownership, while highlighting the immediate outlay for the investor and the deferred costs for the operator. The calculator factors in such variables as:

- Acquisition costs (pipes, installation, loans, etc.)
- Operating costs (maintenance, water losses, pumping energy, etc.)
- End-of-life costs (dismantling, recycling, and so on)

WHAT THE TCO REVEALS

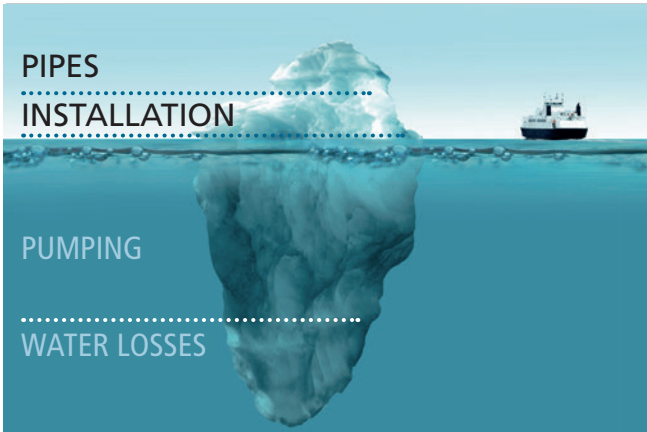

NATURAL® DN 200 PIPE OVER 100 YEARS



EXAMPLES OF TCO-LCA ASSESSMENTS

Assumptions used for the PAM LCA-TCO calculator:

- **NATURAL®** DN 200 and 1200 pipes
- Open-cut installation under normal conditions
- Transported by road (600 km)
- Technical and economic data for Europe (2014)
- 100-year service life

The following values are provided for guidance only, insofar as they are based on hypothetical cases and average data. We disclaim all liability with respect to the values.

TCO ANALYSIS (TOTAL COST OF OWNERSHIP)

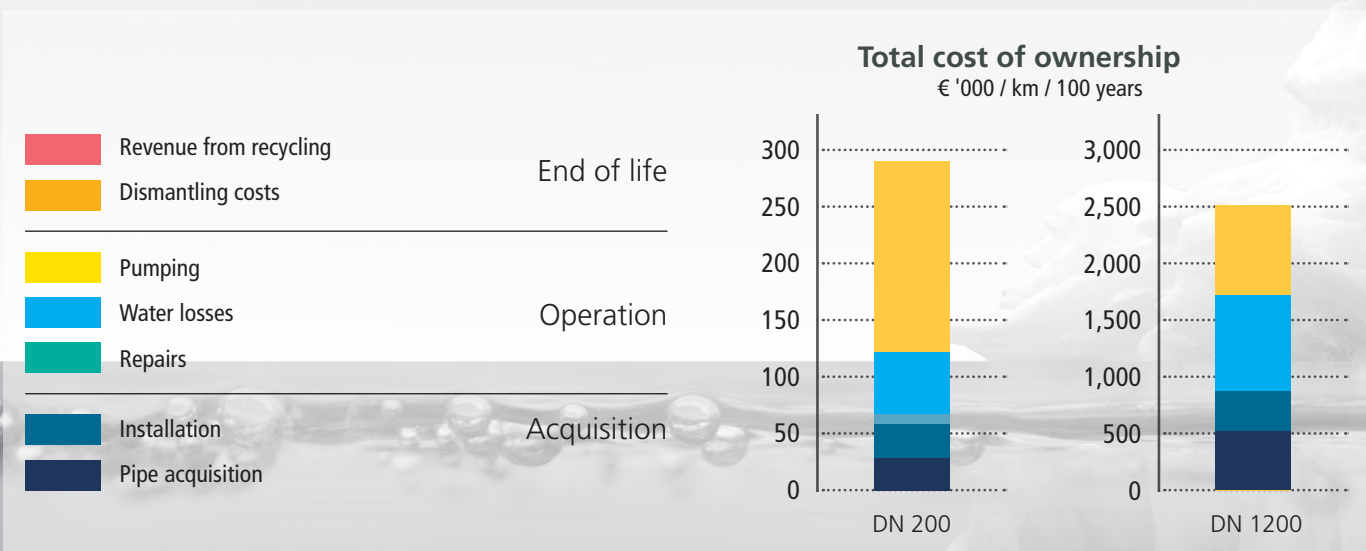

Contact PAM to assess your project.

SUSTAINABLE DEVELOPMENT

Total cost of ownership

LIFECYCLE ASSESSMENT (LCA)

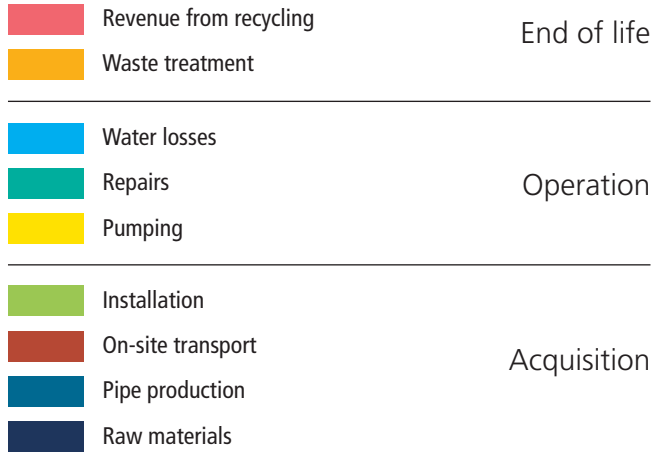

Carbon footprint
Kg CO₂ eq / km / 100 years

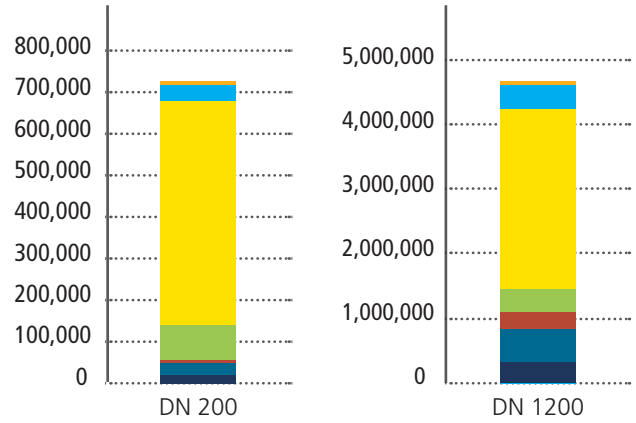

Water use
m³ / km / 100 years

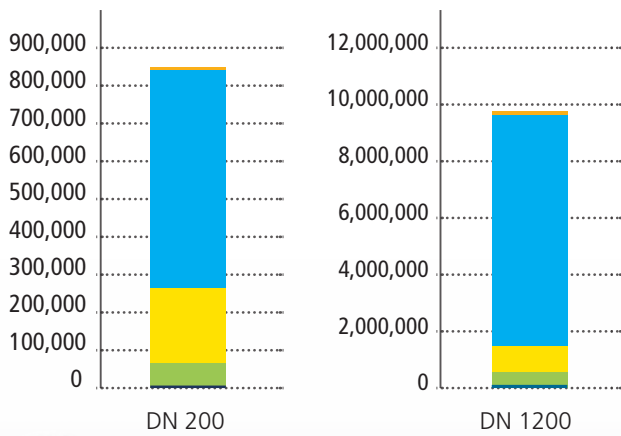

Fossil fuel use
Megajoules / km / 100 years

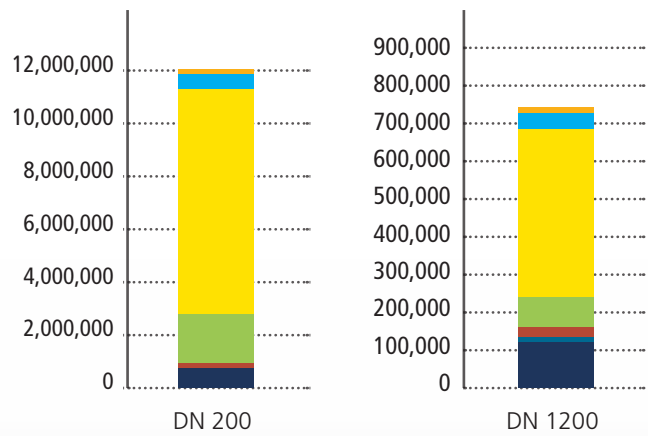



Saint-Gobain PAM APAC

Address: Room 1808, 18th Floor,
Building No.5, Zi Yun Wisdom Plaza,
No. 19 Kazimen Avenue, Qinhuai
District, Nanjing, PRC

**Customer service hotline:
400-8880-198**

**www.saint-gobain.com.cn/en/pam
www.pamline.com**